

# **Neuropsychiatry and Quantitative Electroencephalography in the 21st Century**

**Neuropsychiatry, October, 1(5): 495-514 (doi: 10.2217/npv.11)**

**Robert W. Thatcher, Ph.D.**

**NeuroImaging Laboratory, Applied Neuroscience Research Institute, St. Petersburg, Fl**

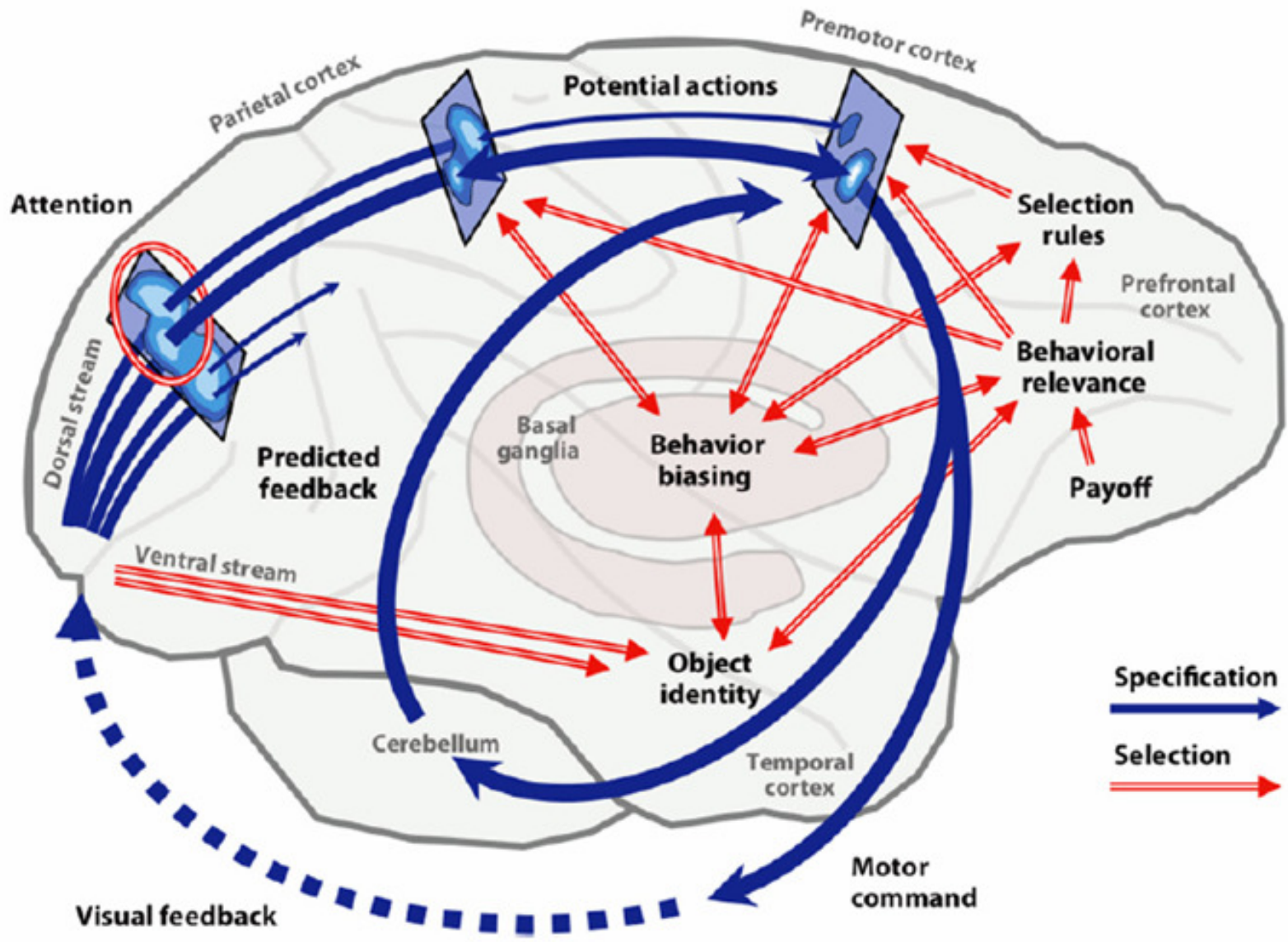
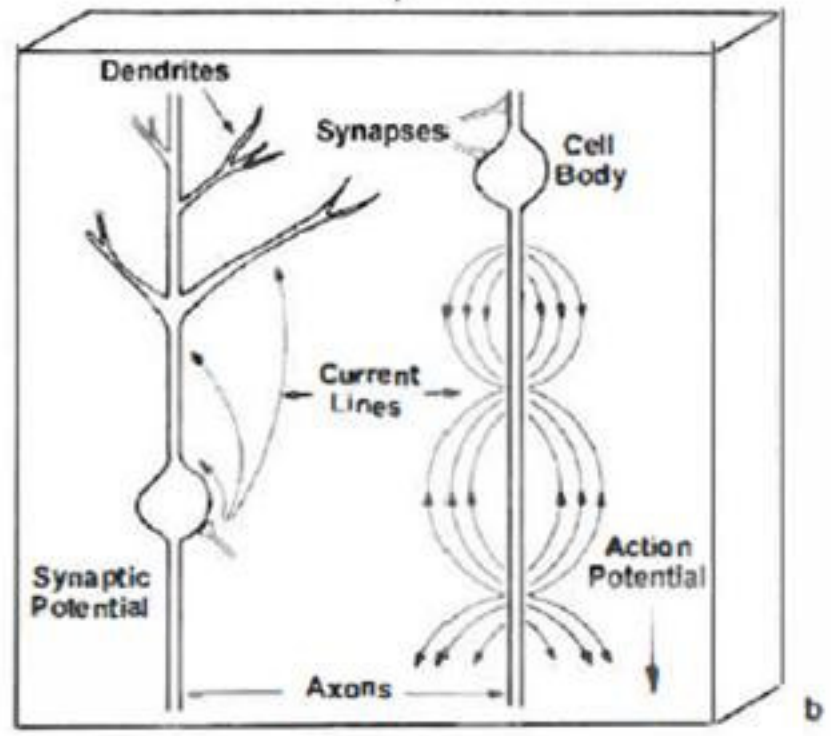
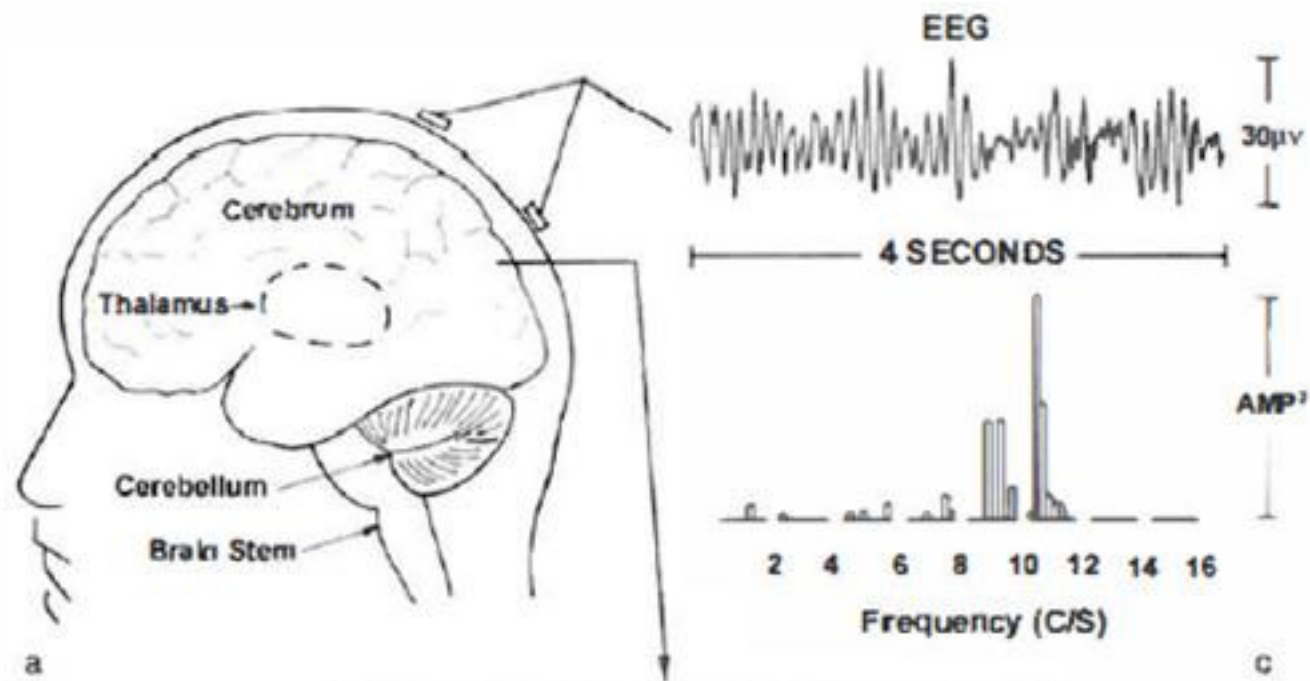
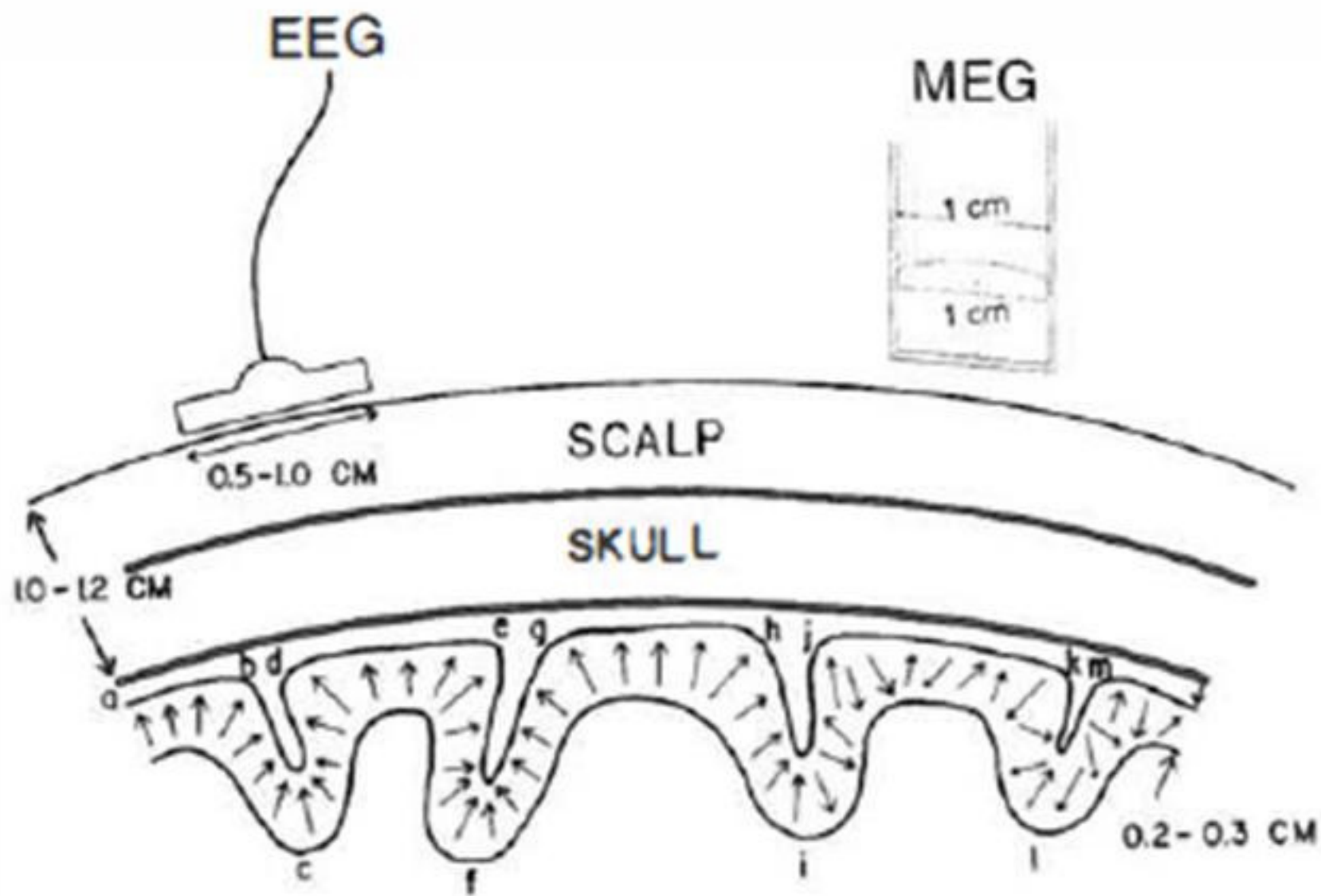

Illustration of brain information flow that can only be measured by the electroencephalogram using computers.  
 Information flow – Millisecond Match-Mismatch From Rabinovich et al, 2012

# **Genesis of the Human Electroencephalogram - EEG**

- 1- Pyramidal Neuron Dipoles**
- 2- Oscillations In an Approx. 2mm thick sheet**
- 3- Summated Local Field Potentials (LFP)**
- 4- Amplitude = Proportion of Synchronous/Square Root  
of Proportion of Asynchronous Generators**
- 5- Pacemakers and Resonance**





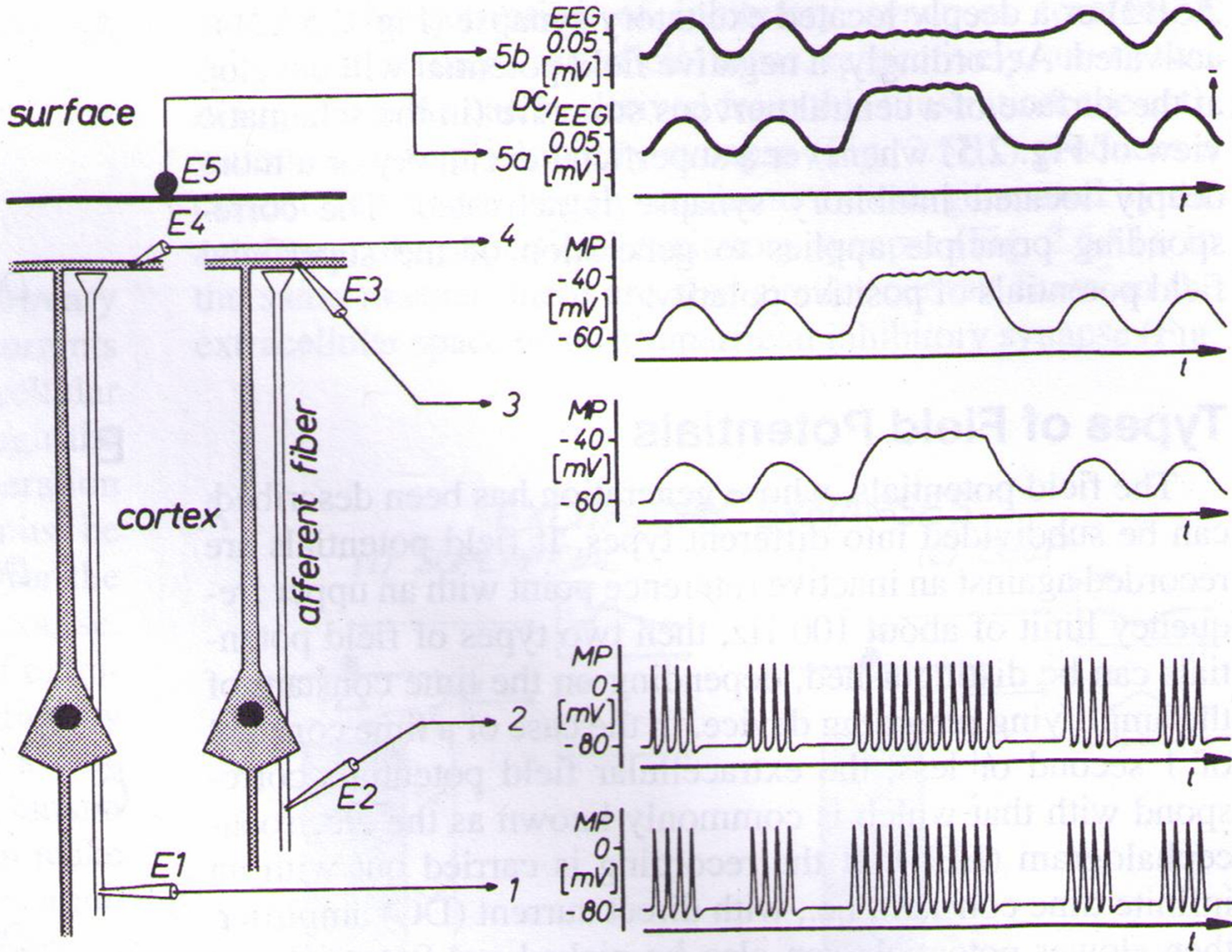

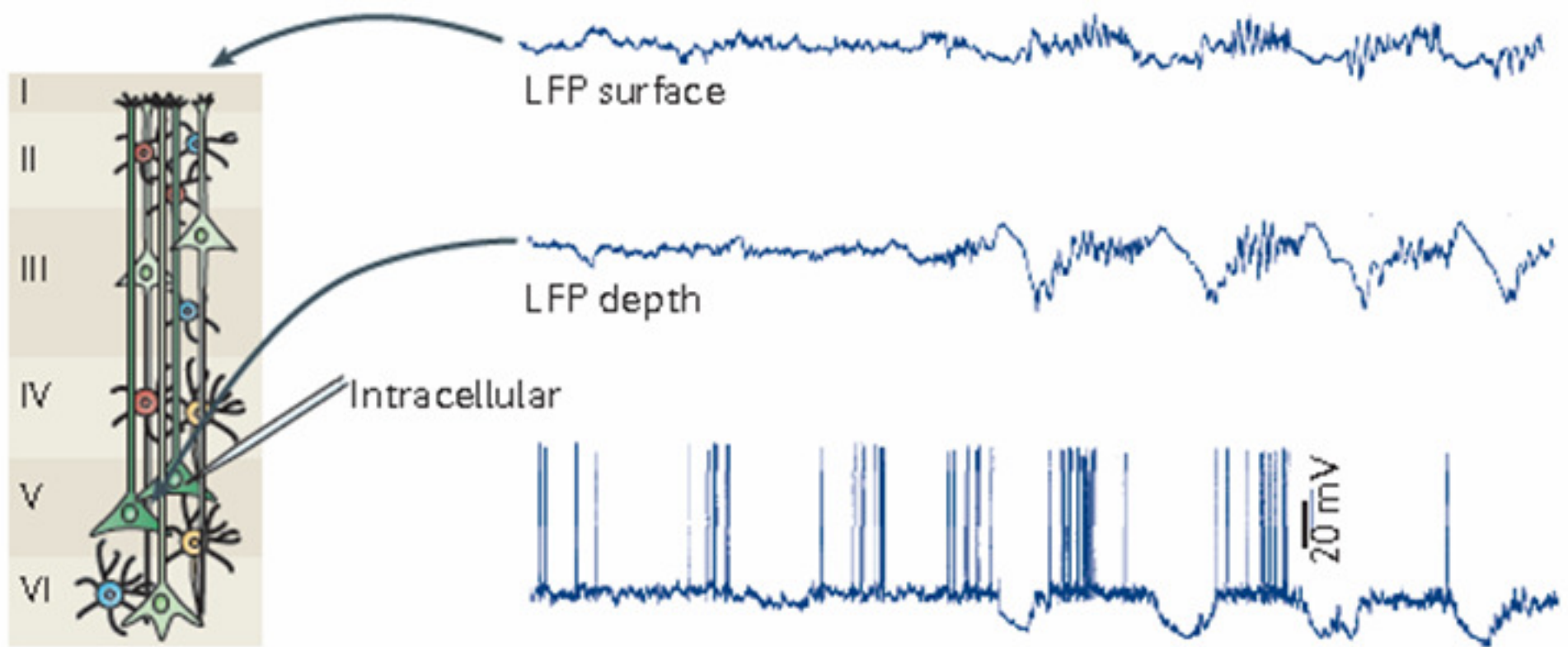

### A Local scale

Spatial resolution

• -1  $\mu\text{m}$

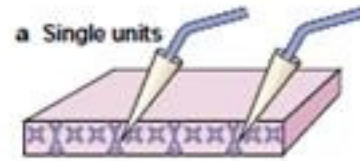

• -1 mm

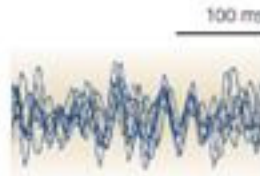
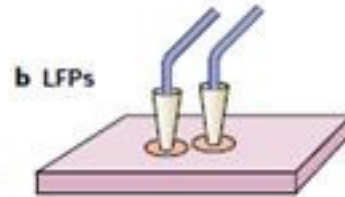

• -1 cm

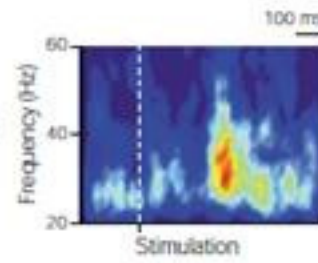
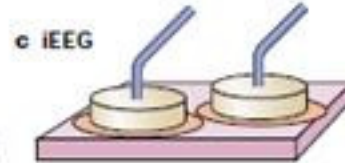

Surface diffusion

• -1 cm

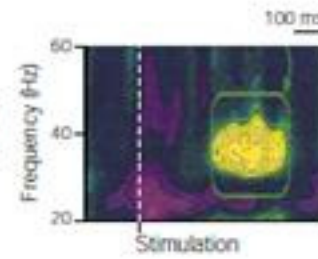
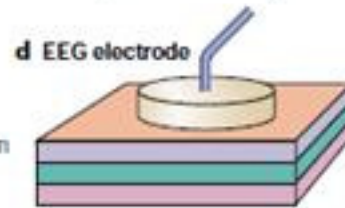

### B Large scale

>2 cm



Distant brain regions

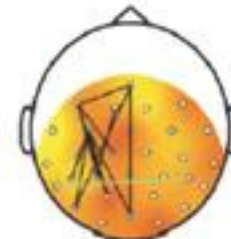

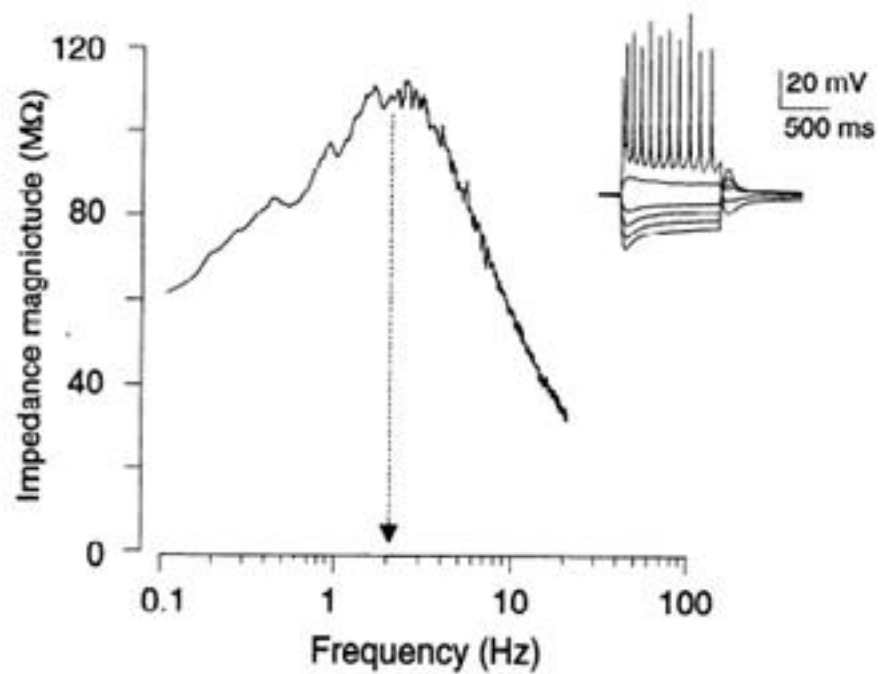
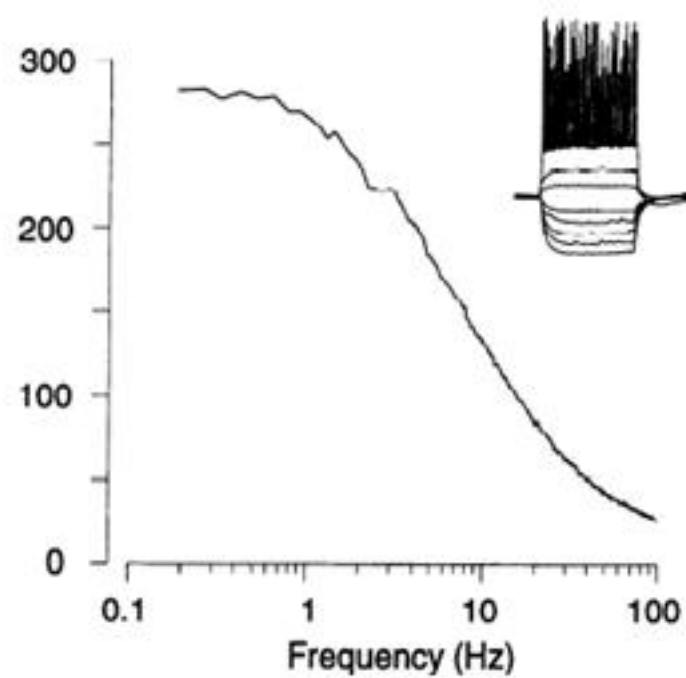
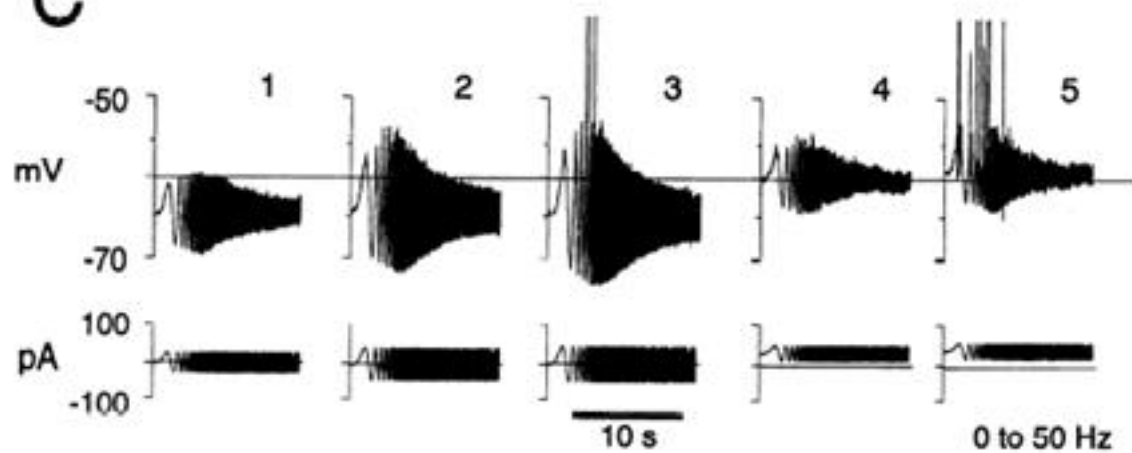
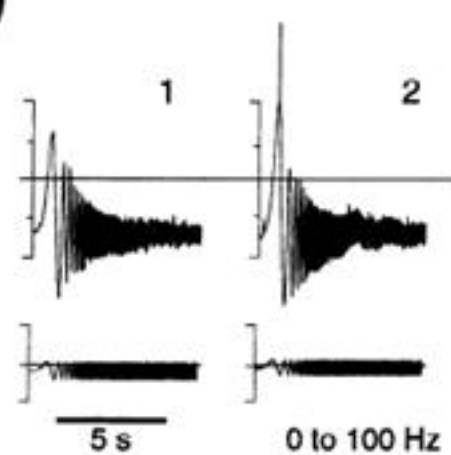
**A****B****C****D**

Connections between  
excitatory and  
inhibitory neurons

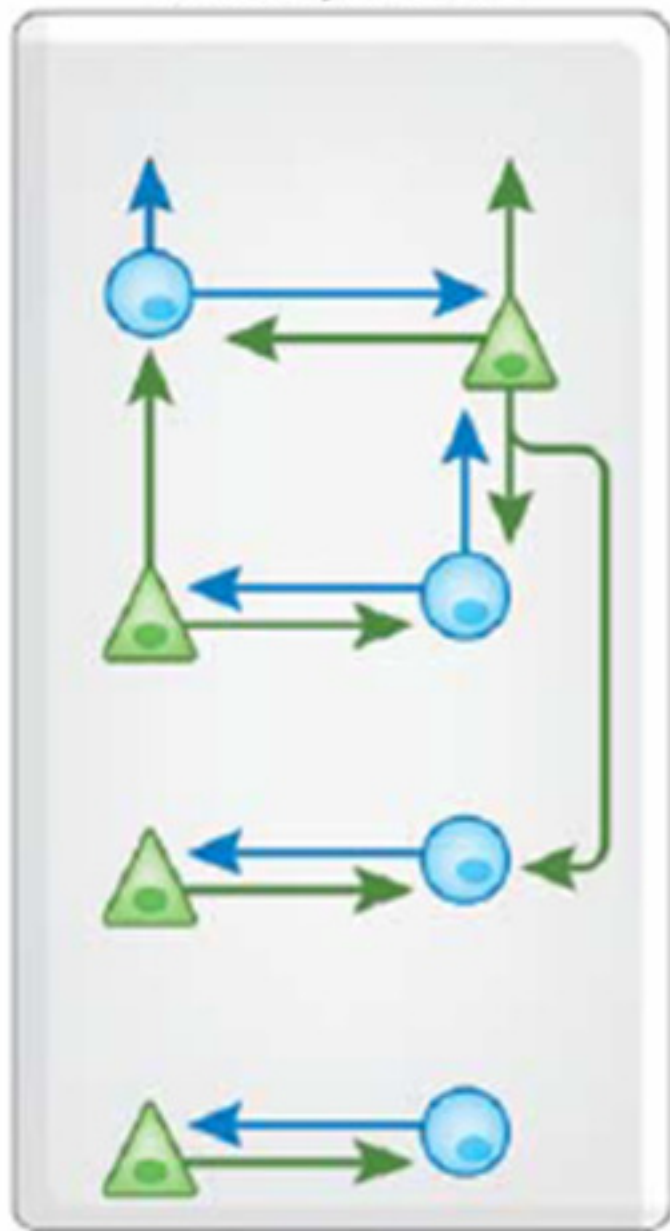

Cortical  
layer



Connections between  
excitatory neurons

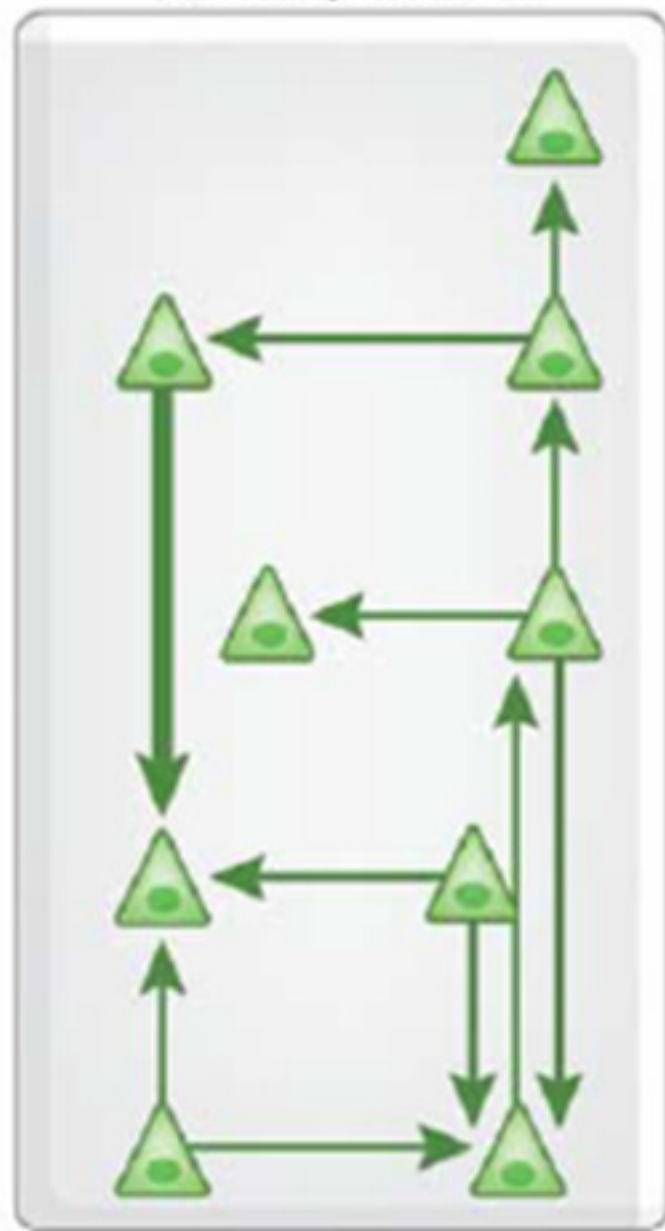

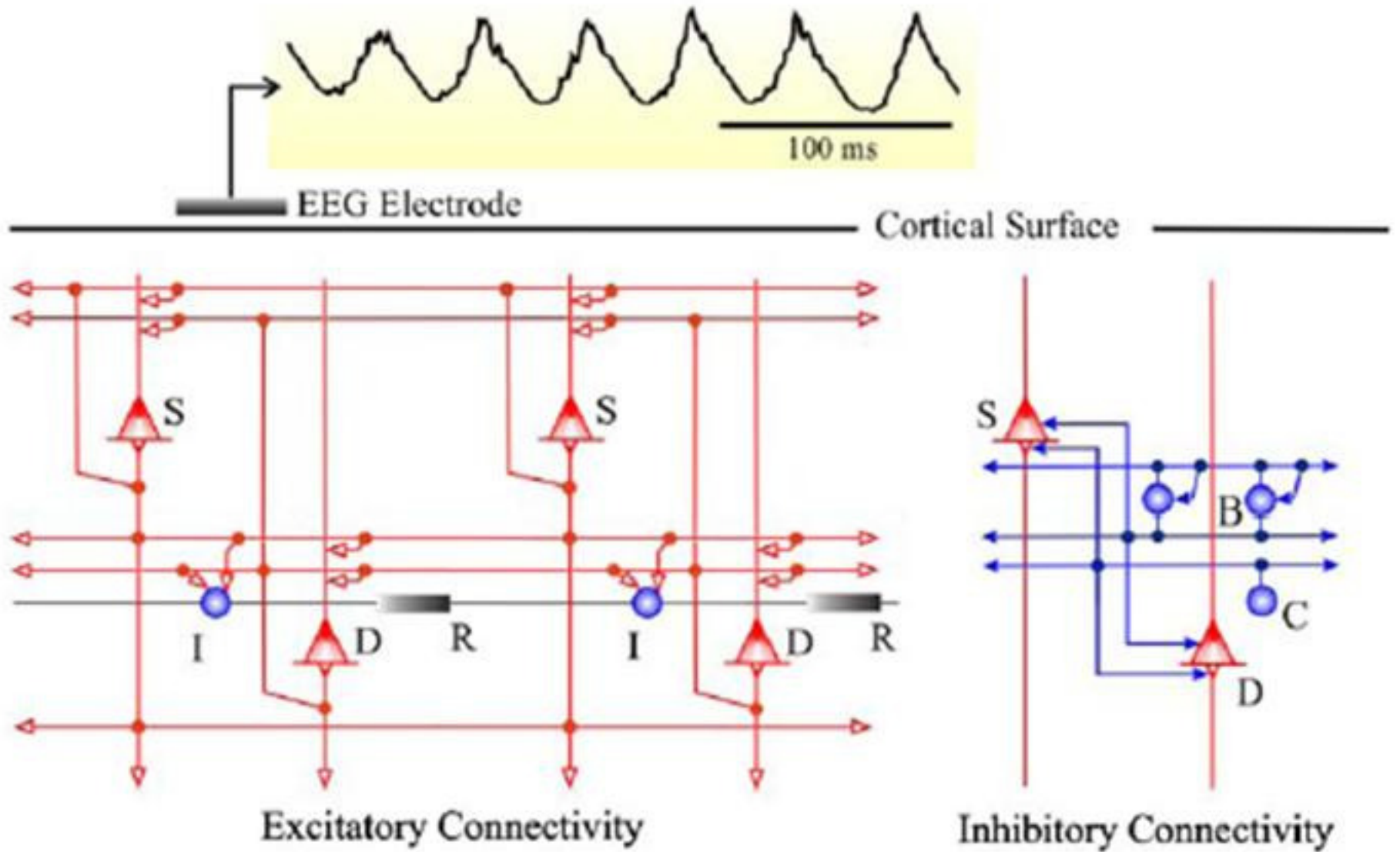

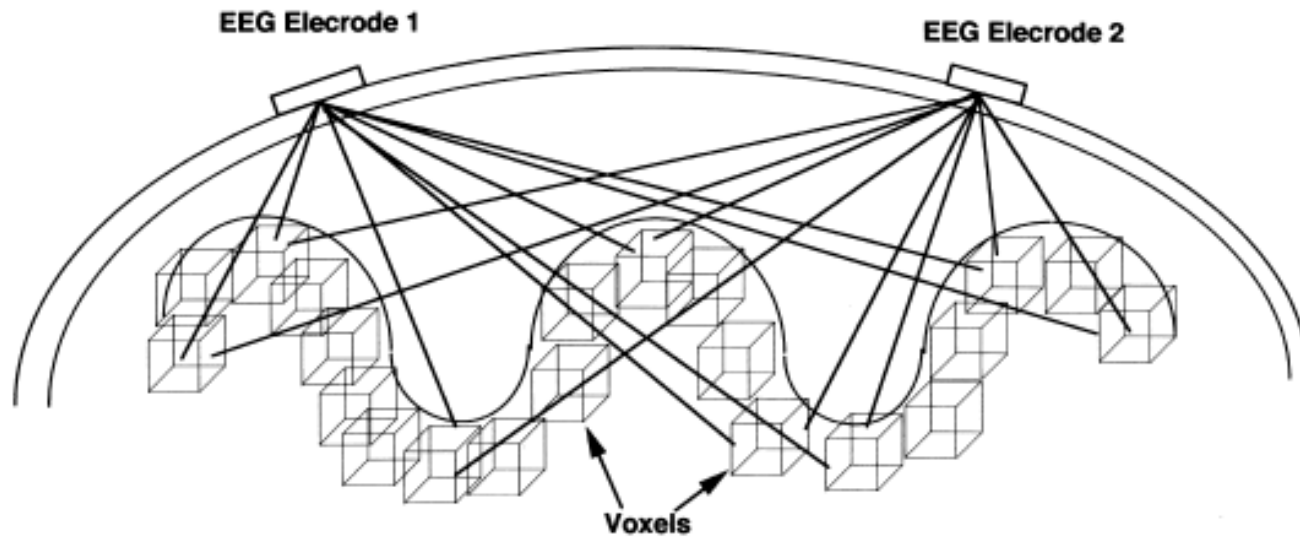

**EQUIVALENT  $T_2$  VOXEL  
DIPOLE MOMENT DENSITY**

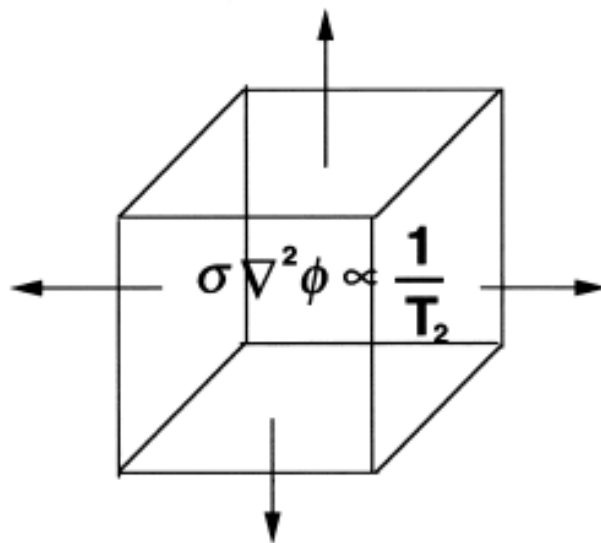

**EQUIVALENT EEG  
RESONANCE CIRCUIT**

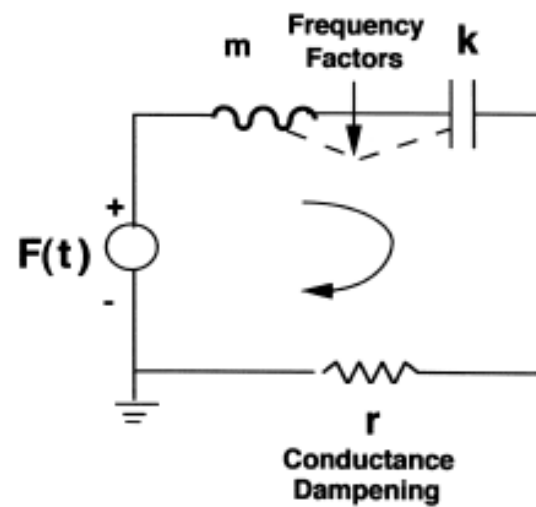

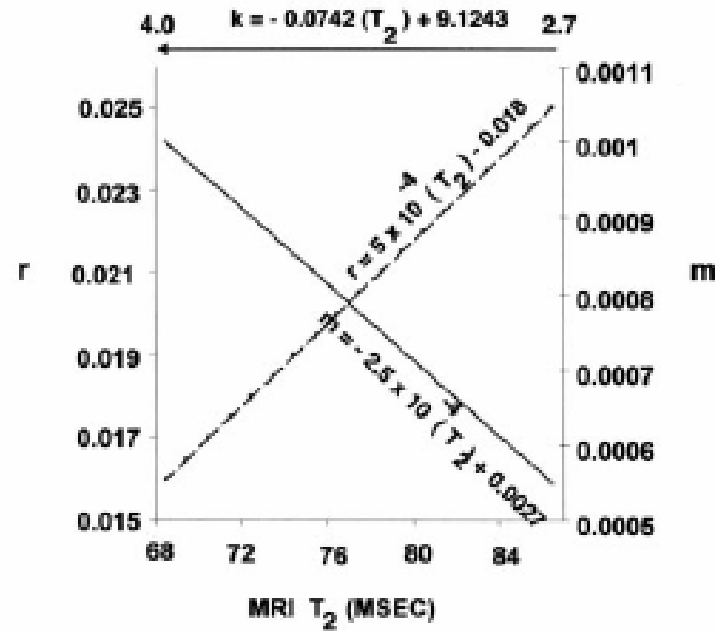
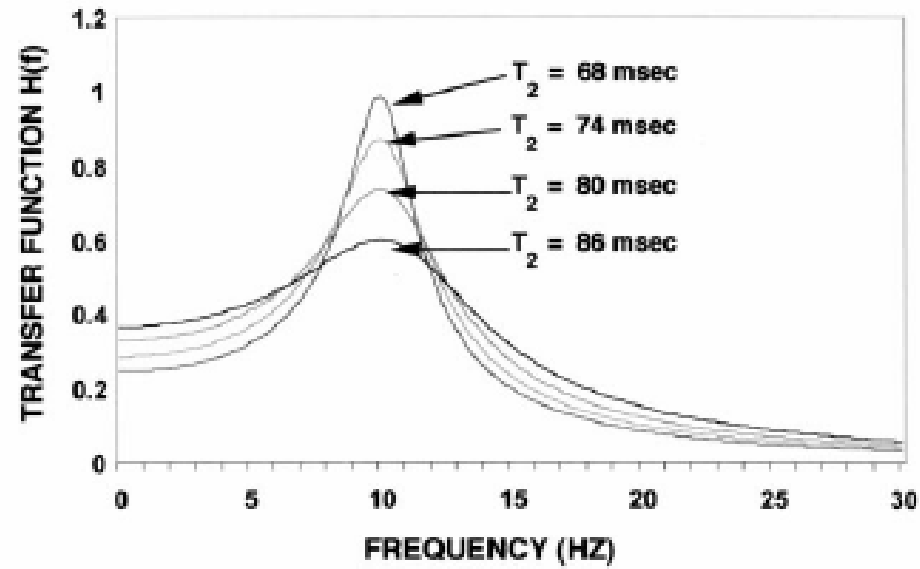
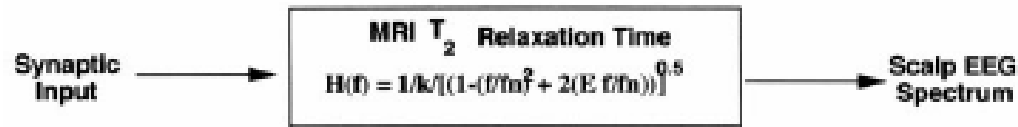

# Frequencies of the EEG

- 1- All Pyramidal Neurons can Oscillate from approx 1 Hz to 300 Hz
- 2- Membrane Potential &  $\text{Ca}^{++}$ ,  $\text{Na}^+$ ,  $\text{K}^+$  ionic conductance 1 – 20 Hz
- 3- Pacemakers in Limbic, Thalamic and Cortical systems
- 4- Local Inhibitory Feedback

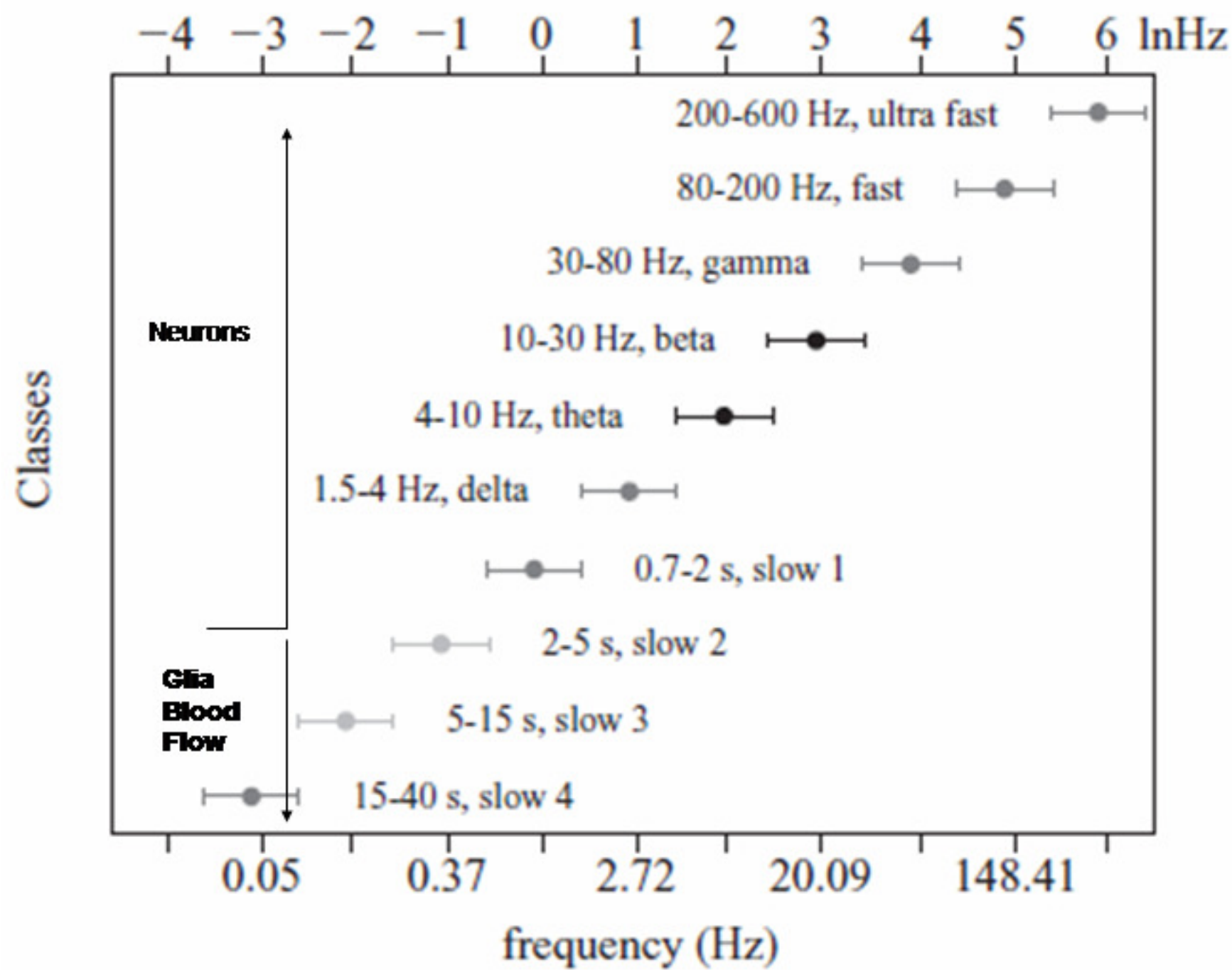

# Two Compartments of the Frequency Spectrum of Bursts in EEG Absolute Amplitude

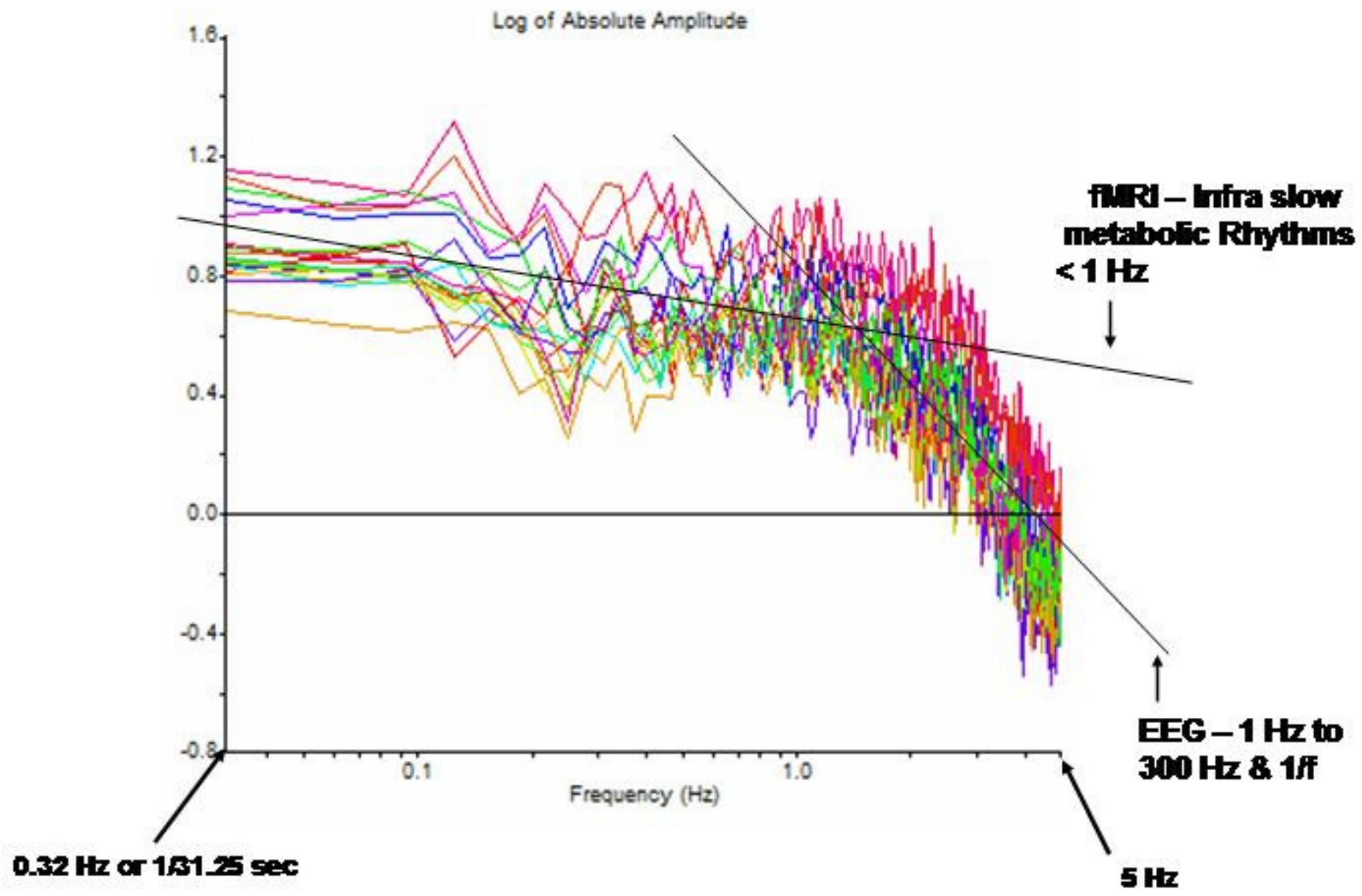

# Cross-Frequency Phase Lock and Phase Shift Spectrum

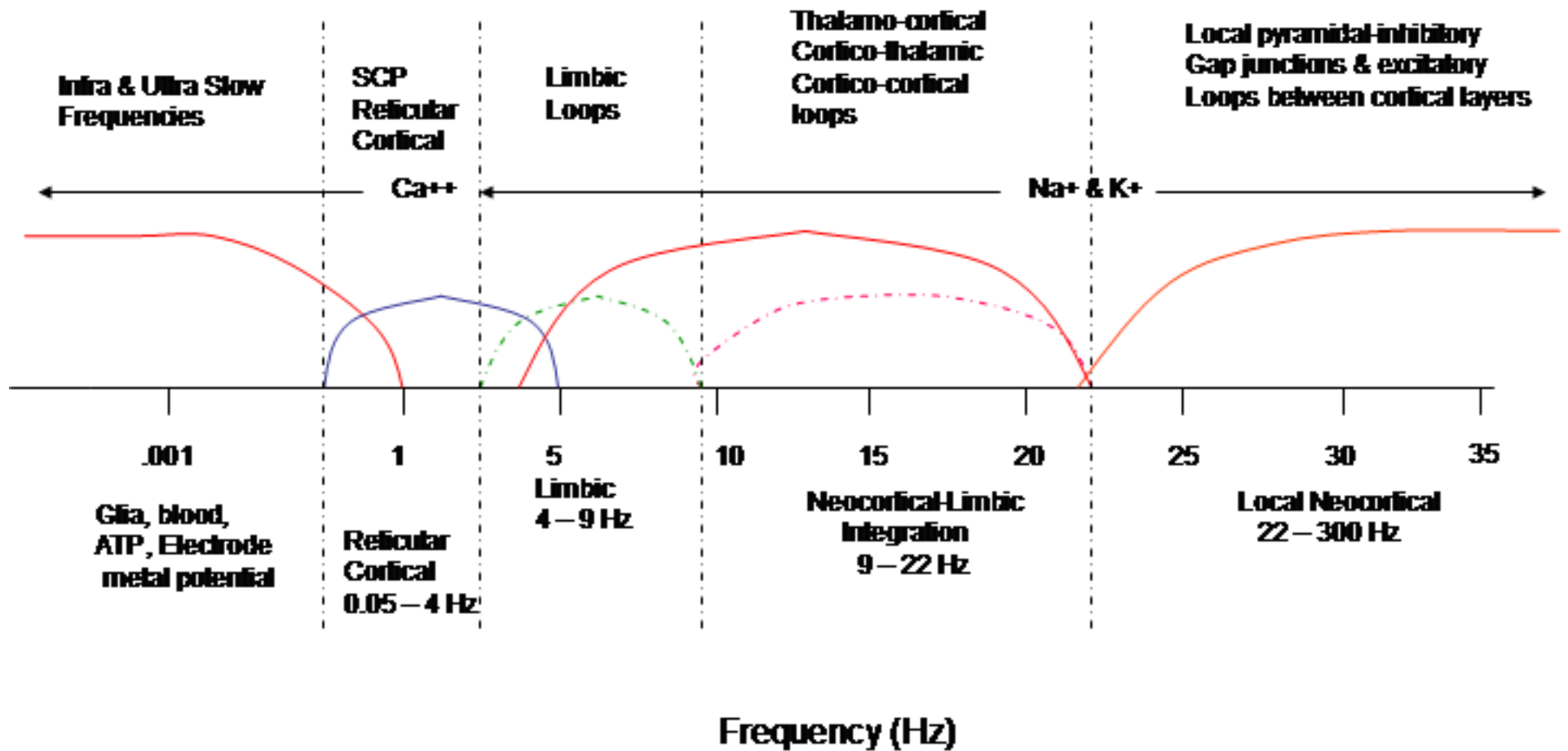

## **In-Phase vs Anti-Phase**

**How Neurons are Selected for  
Brief Periods of Time**



### LFPs & In-Phase Action Potentials

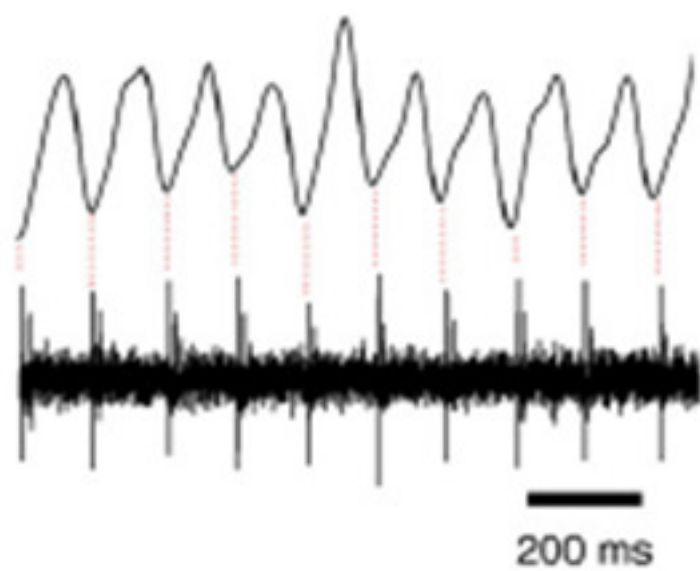

in phase

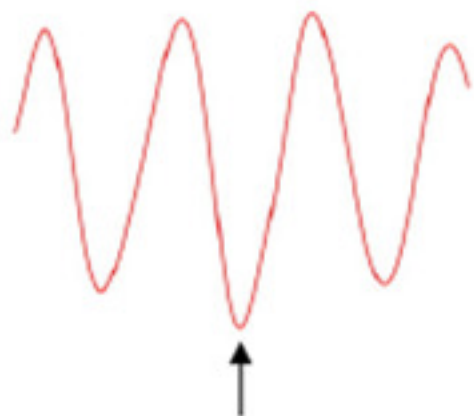

### LFPs & Anti-Phase Action Potentials

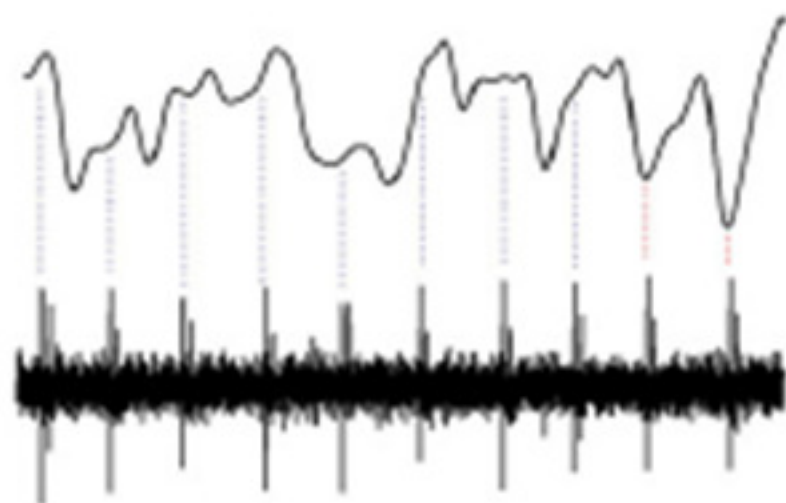

antiphase

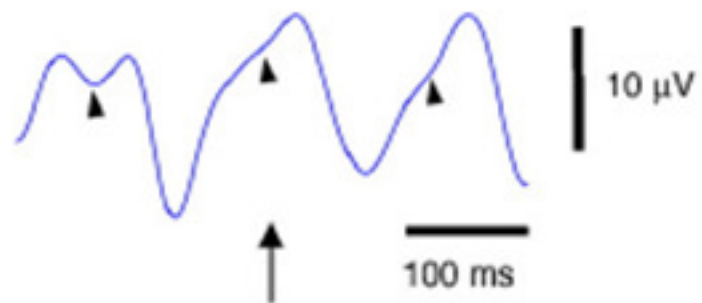

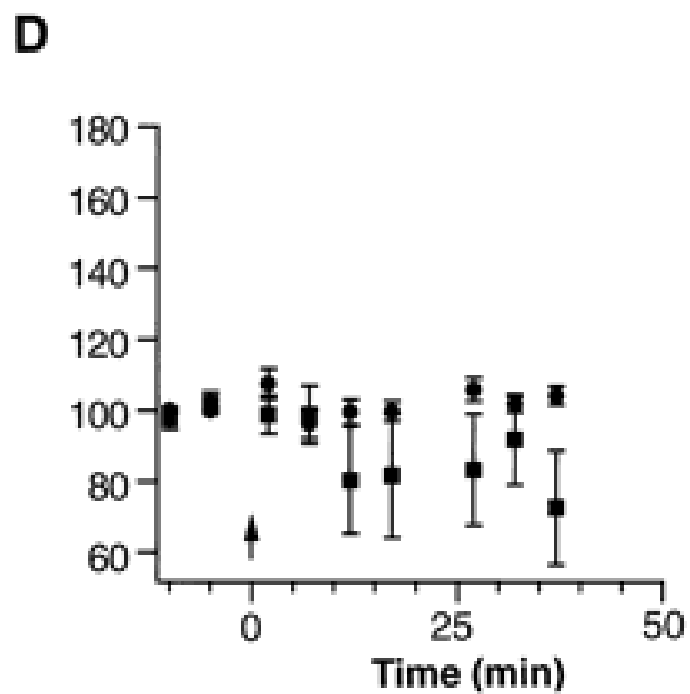
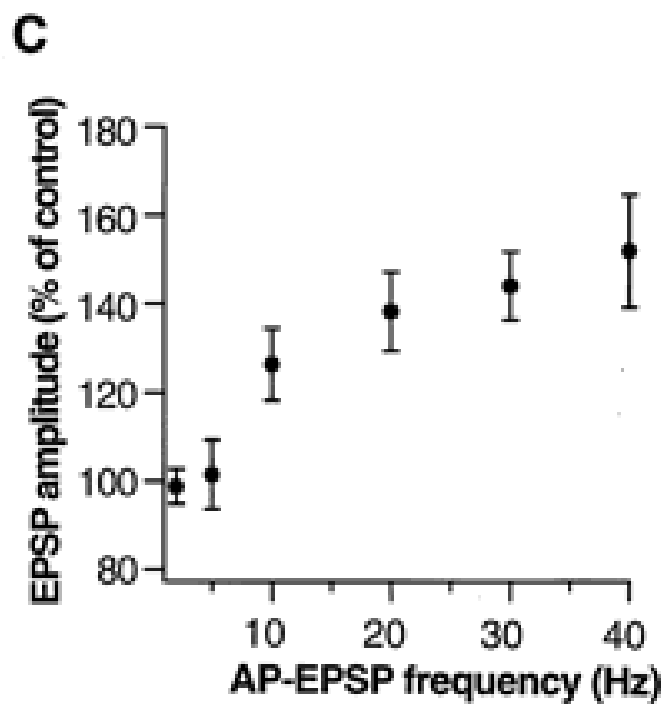
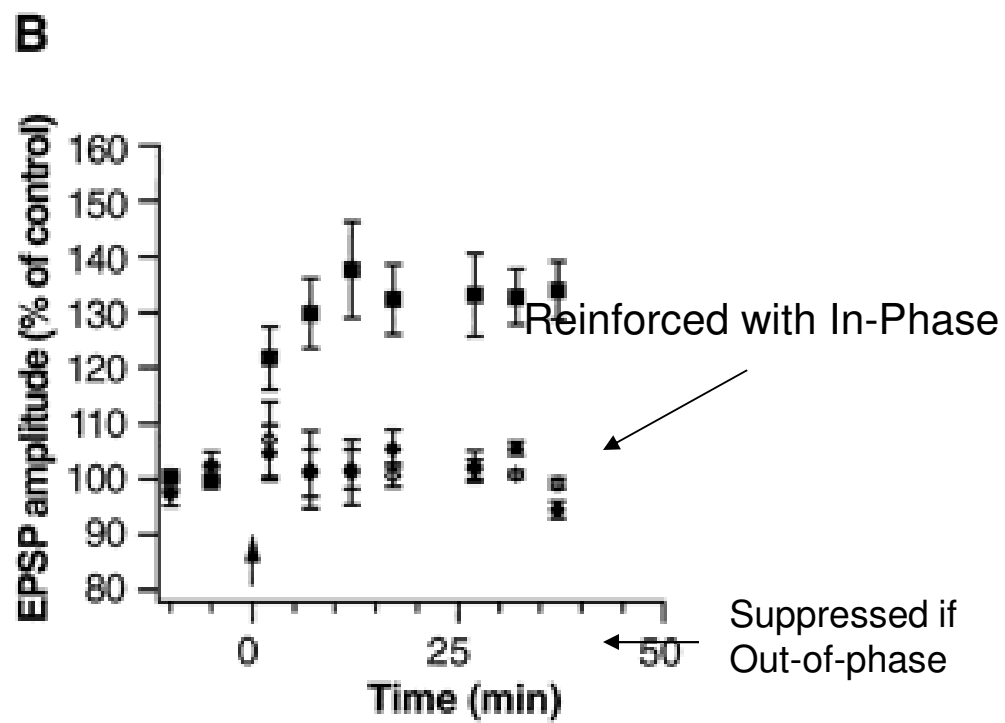
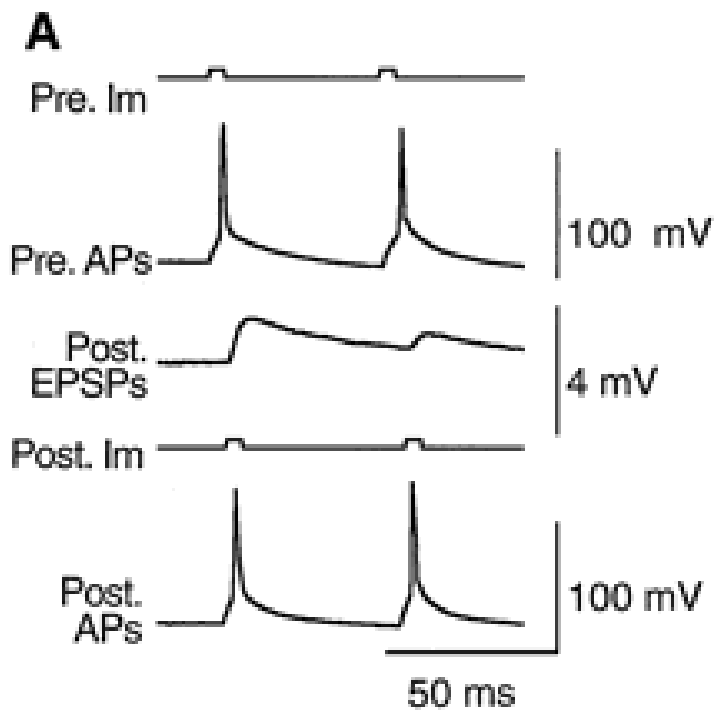

**a Peak** **b Trough**



In-Phase is Reinforced

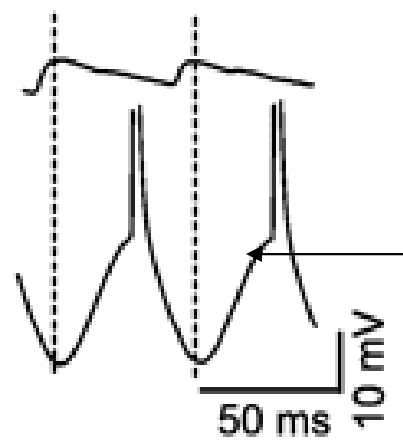
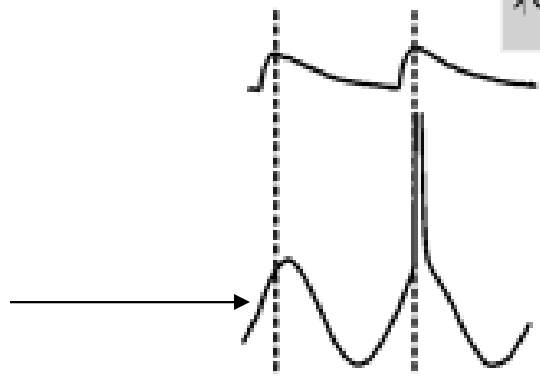

Out-of-Phase is Suppressed

50 ms 10 mV

**c Peak oscillation pairing** **d Trough oscillation pairing**

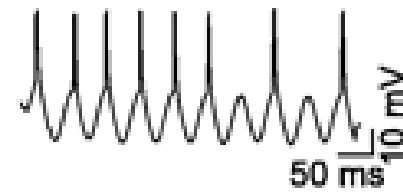

ii

EPSP ampl. (%)

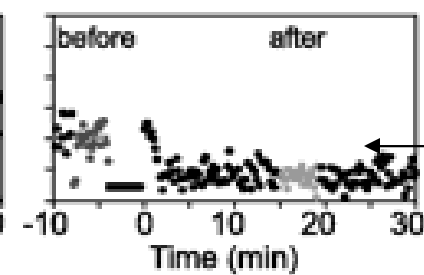
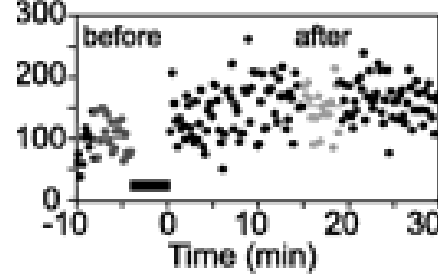

In-Phase is Reinforced

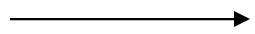

Out-of-Phase is Suppressed

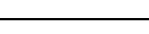

iii



50 ms 1 mV

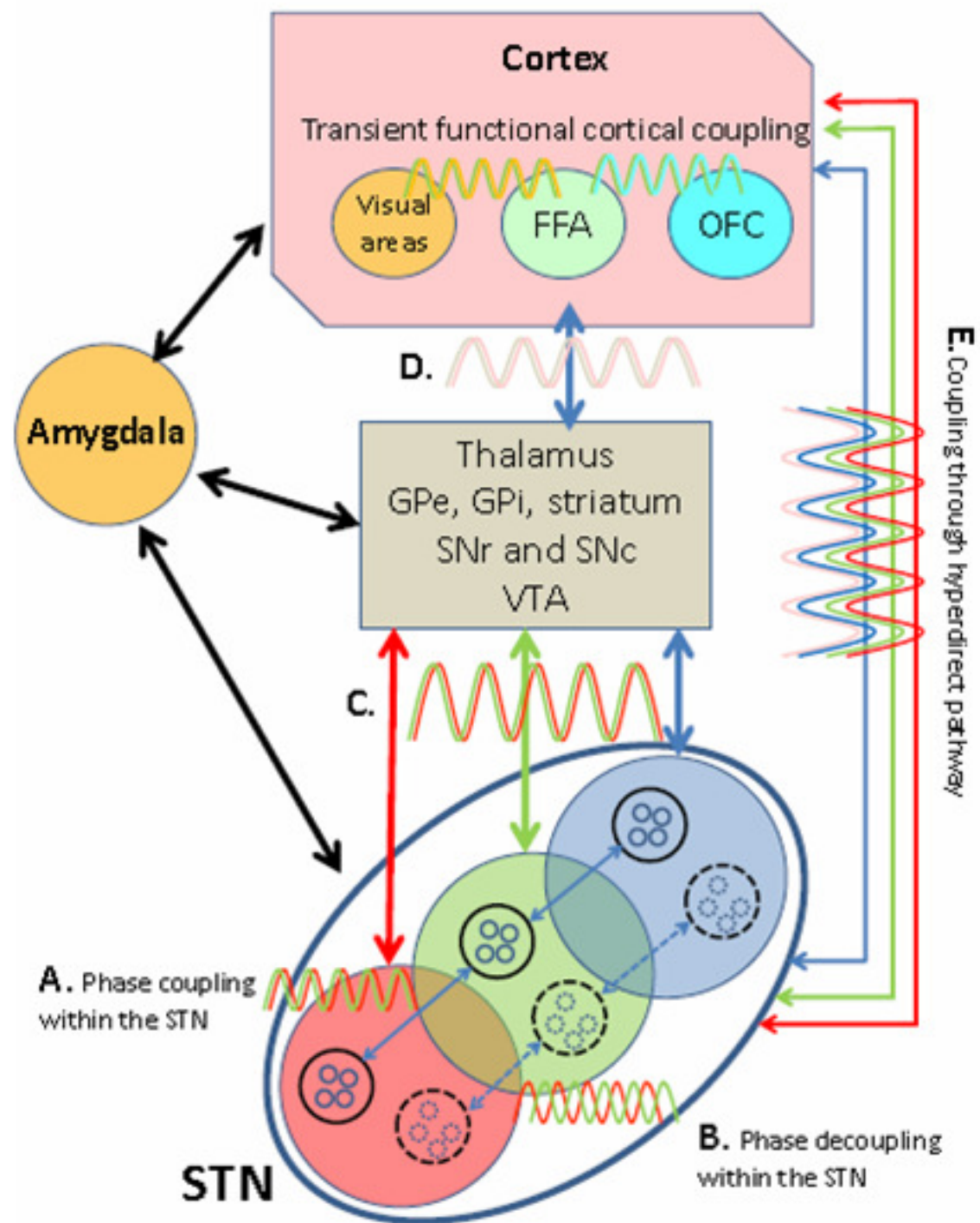

# **What is EEG Phase Difference and Coherence**

**Note: ICA & PCA Reconstruction  
Obliterate the Phase Differences  
Present in the Original EEG Recording**

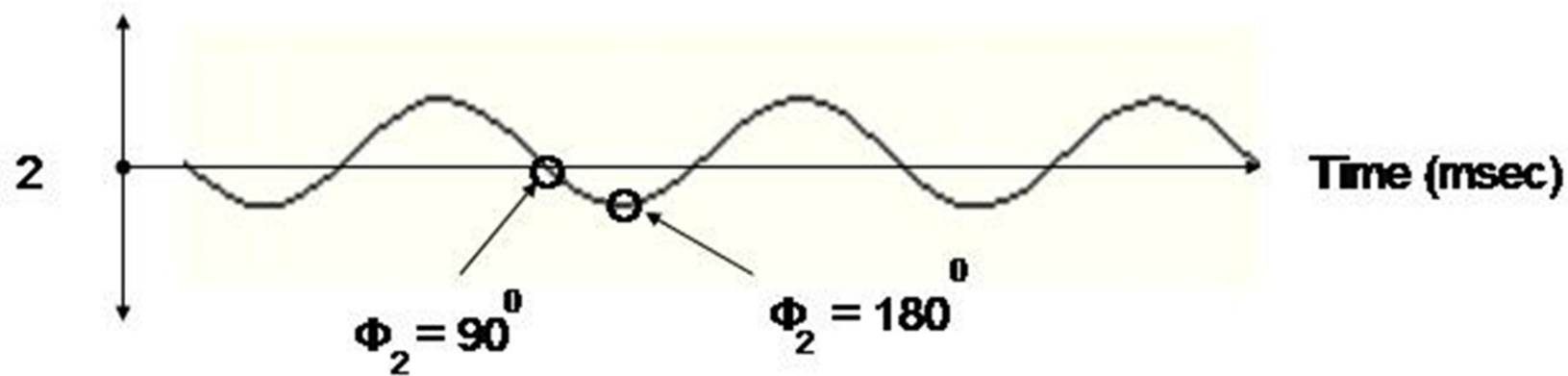
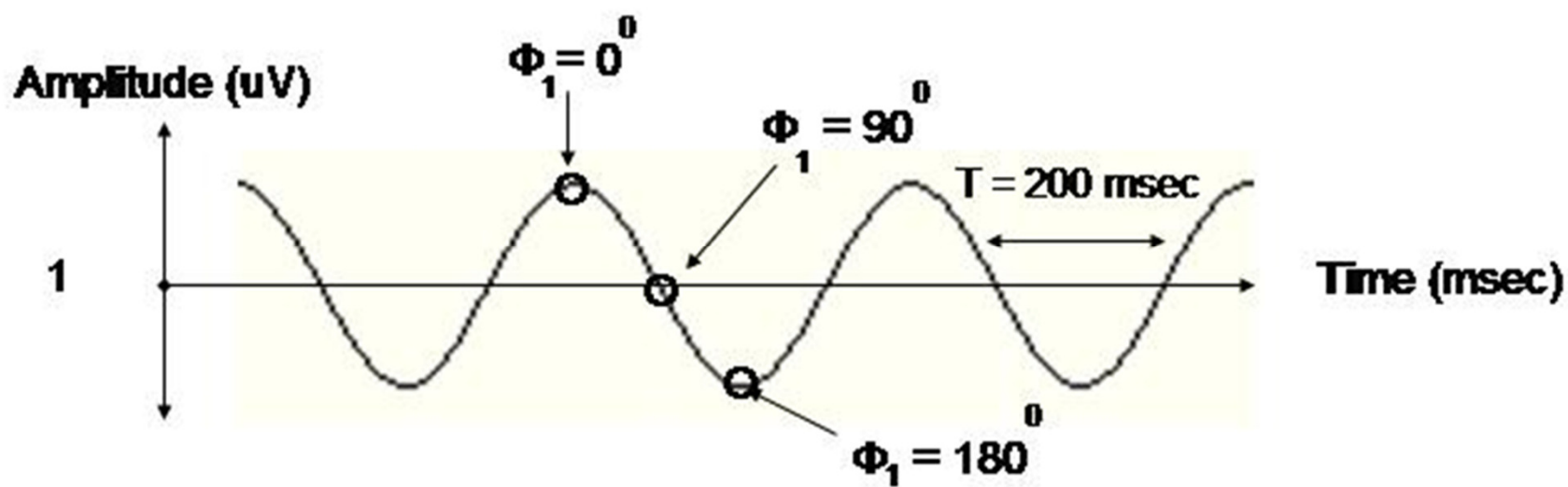

Phase Difference =  $\Phi_1 - \Phi_2 = 90^\circ$

**Coherence is high when phase delays are clustered or grouped together. Magnitude of coherence =  $r$**

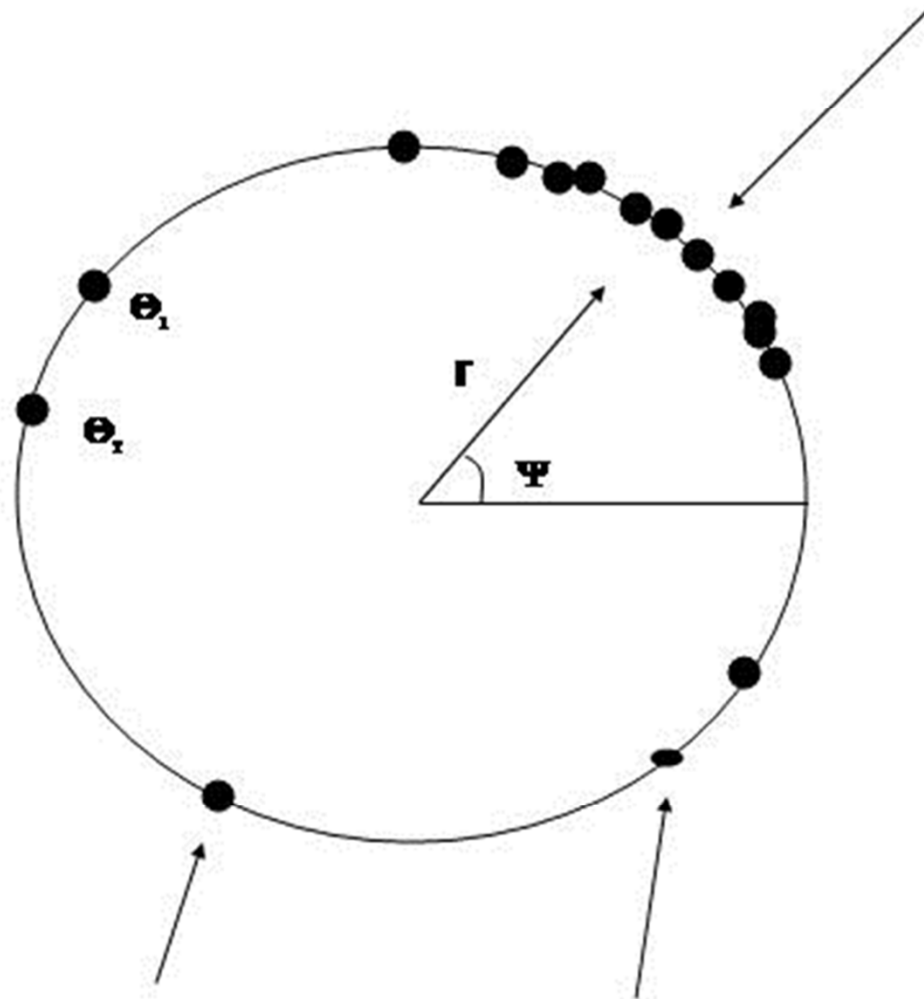

**Coherence is lower when phase delays are scattered**

# **How to Measure Phase Shift and Phase Lock**

## **Phase Reset and Neural Resource Selection and Allocation**

**Note: ICA Obliterates Time & Phase Differences  
Between Channels and Cannot be Used  
for These Type of Analyses**

# EEG Phase Reset as a Phase Transition in the Time Domain

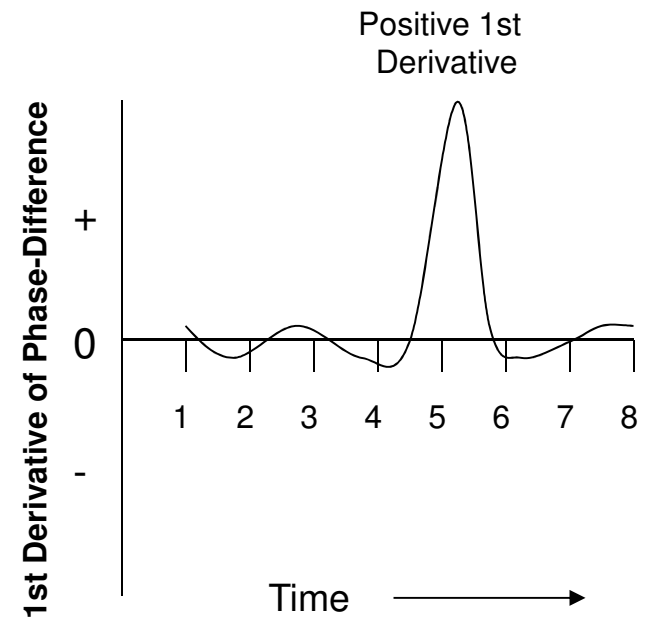
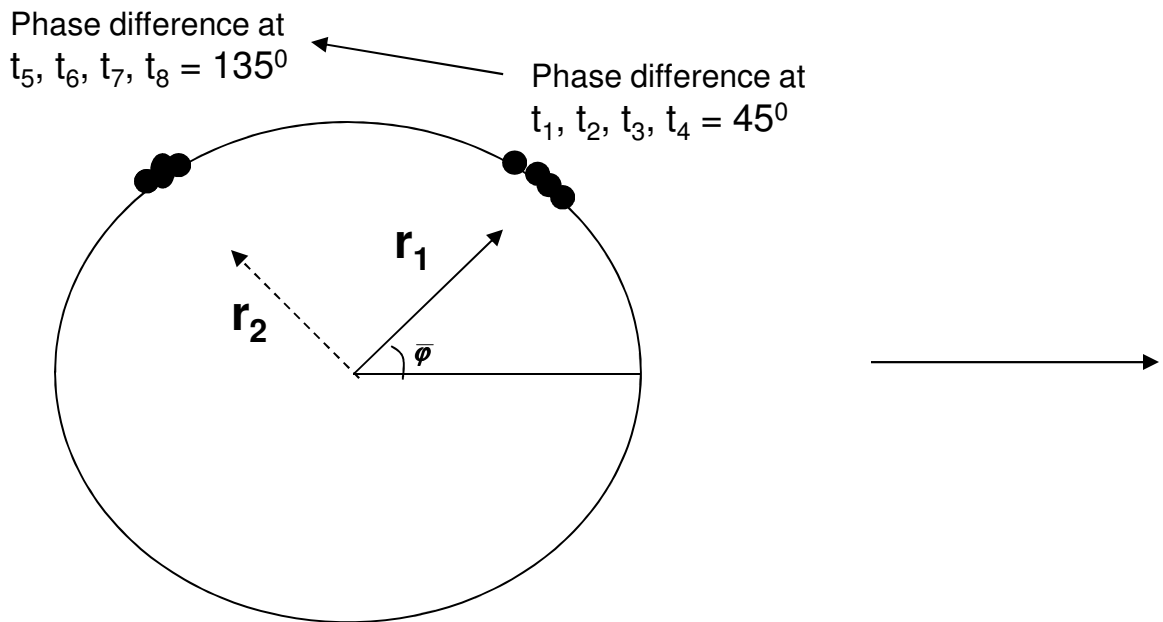
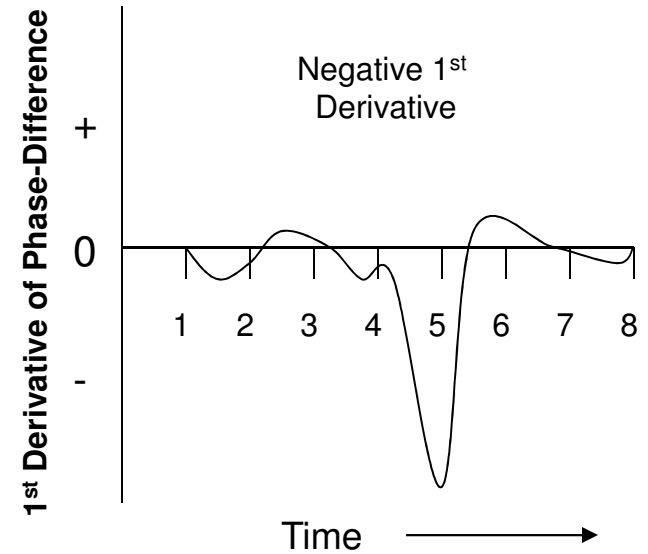
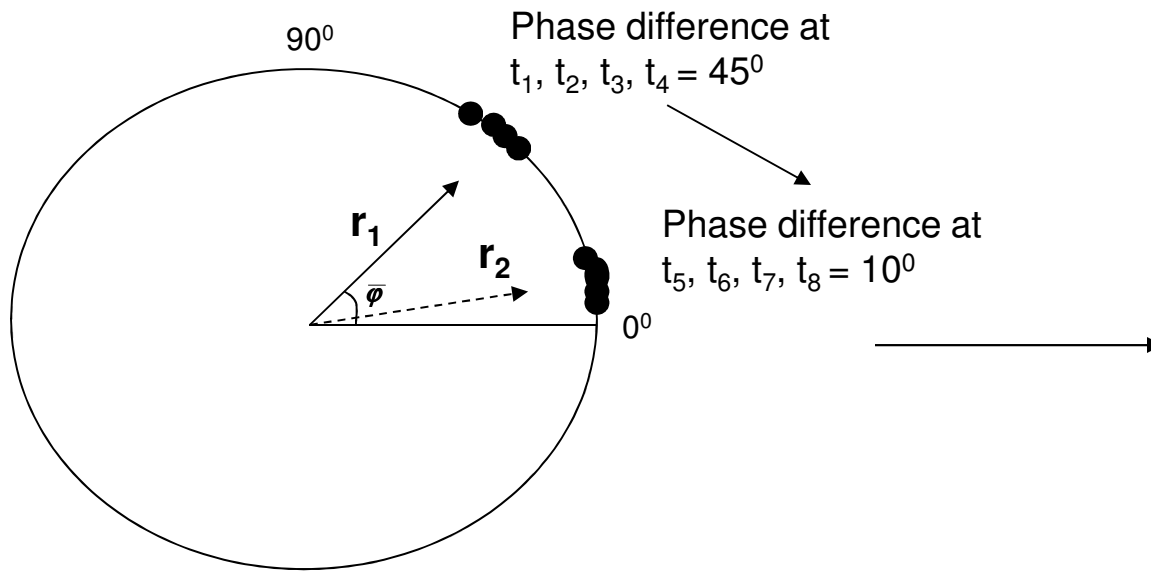

# Phase Reset Metrics

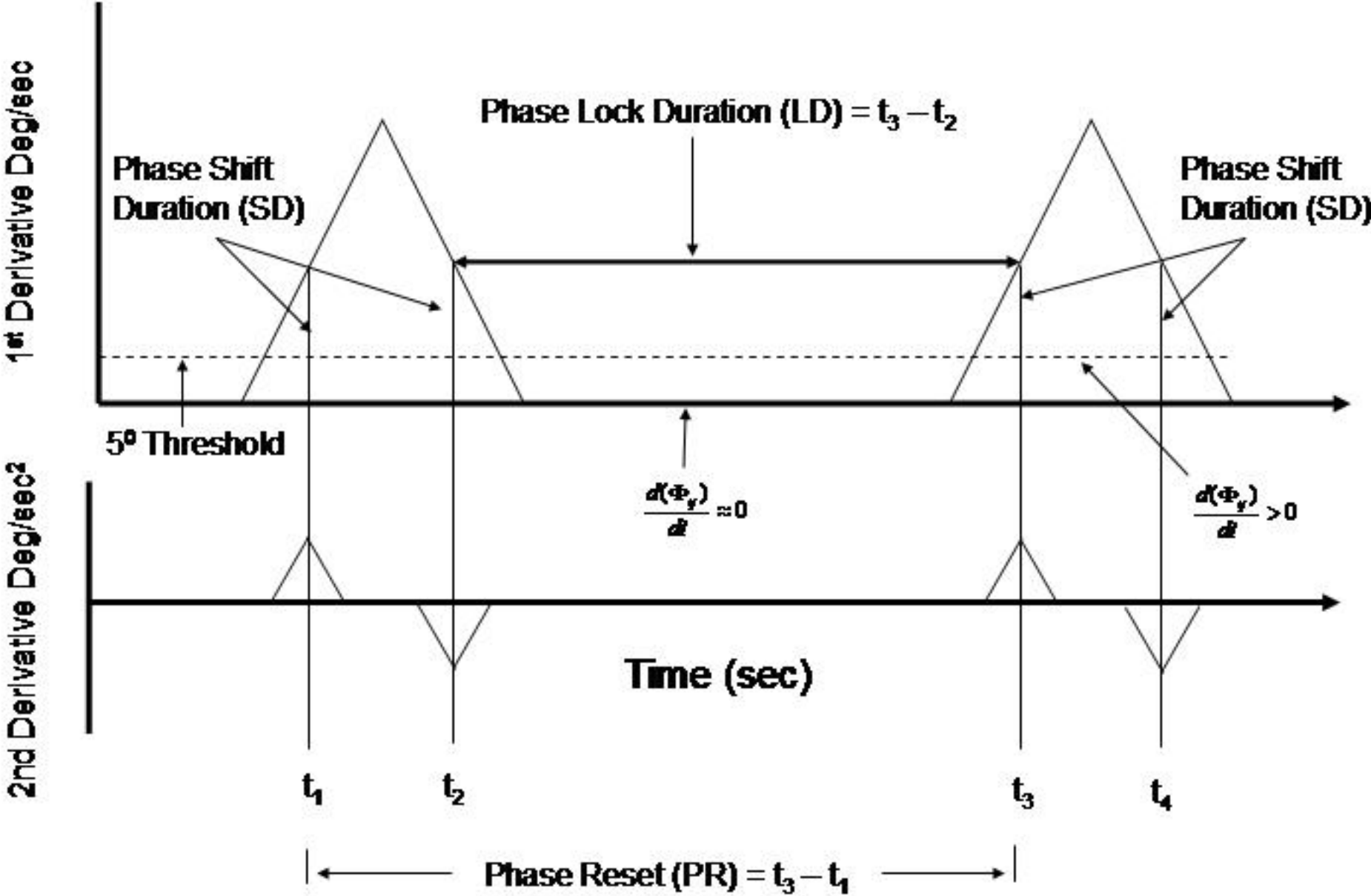

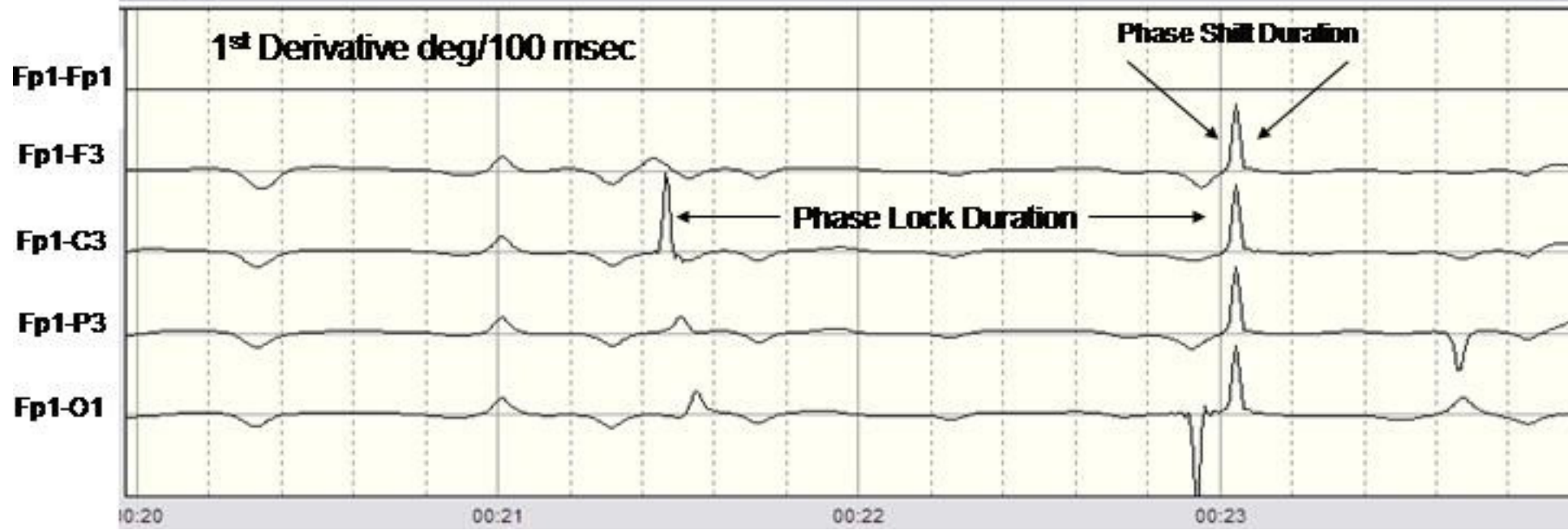
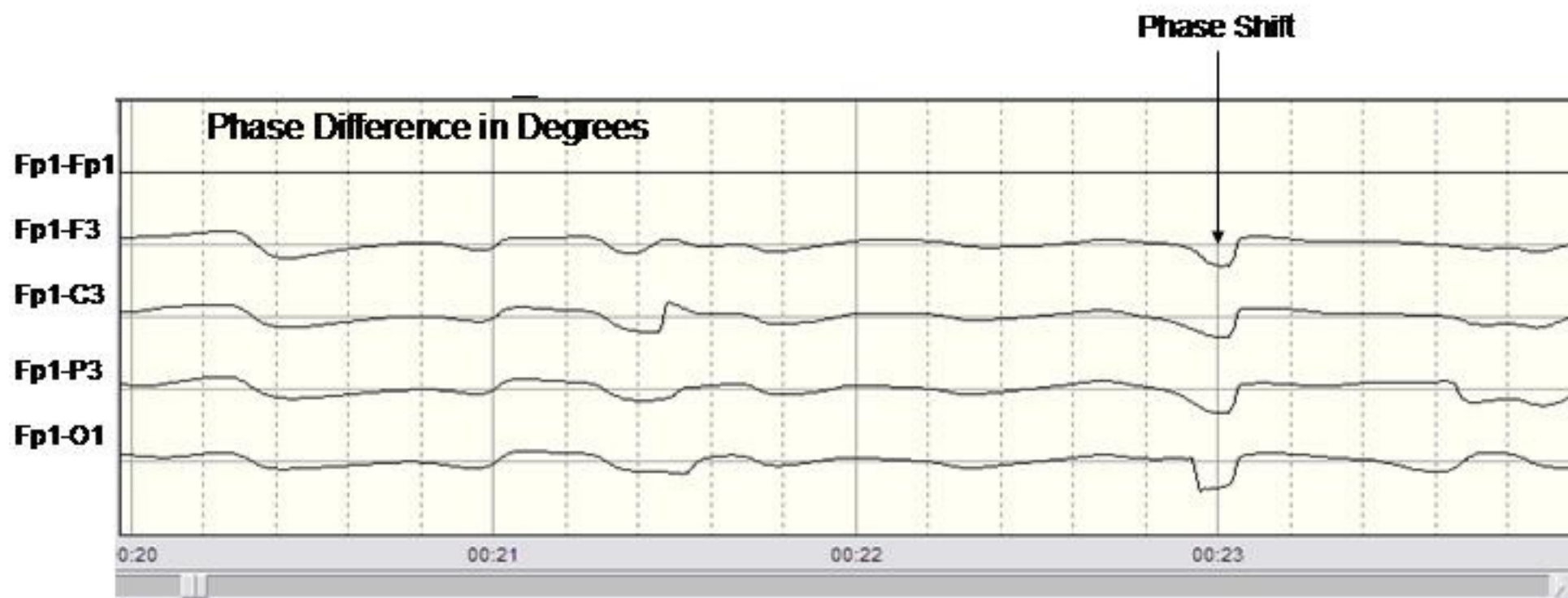

# Development of Phase Shift Duration

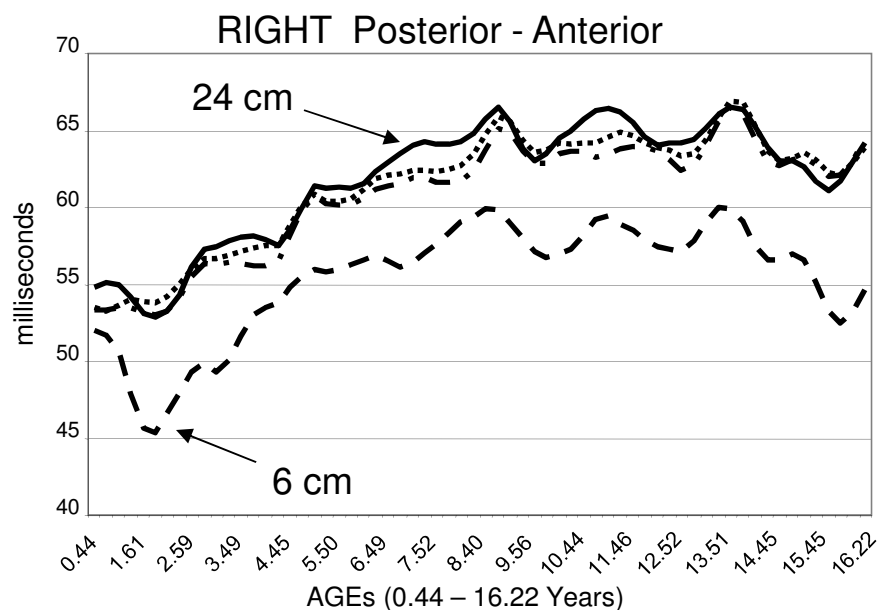
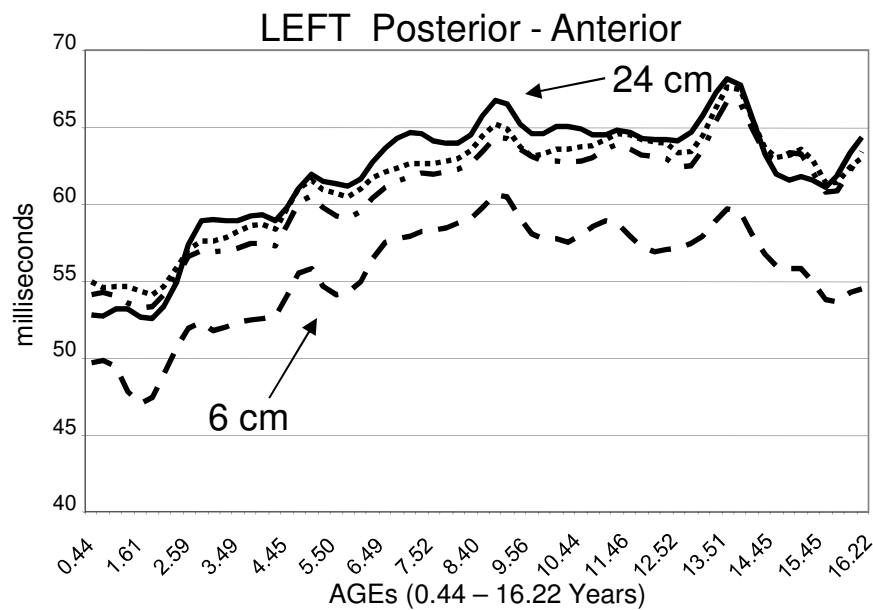
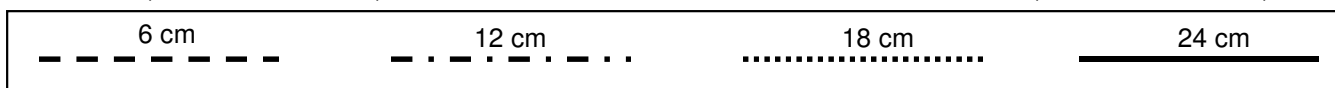
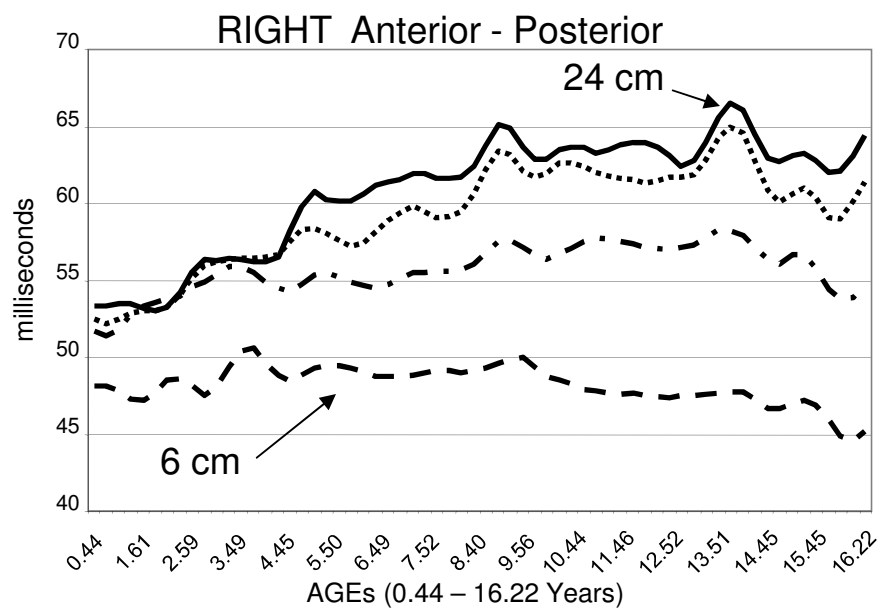
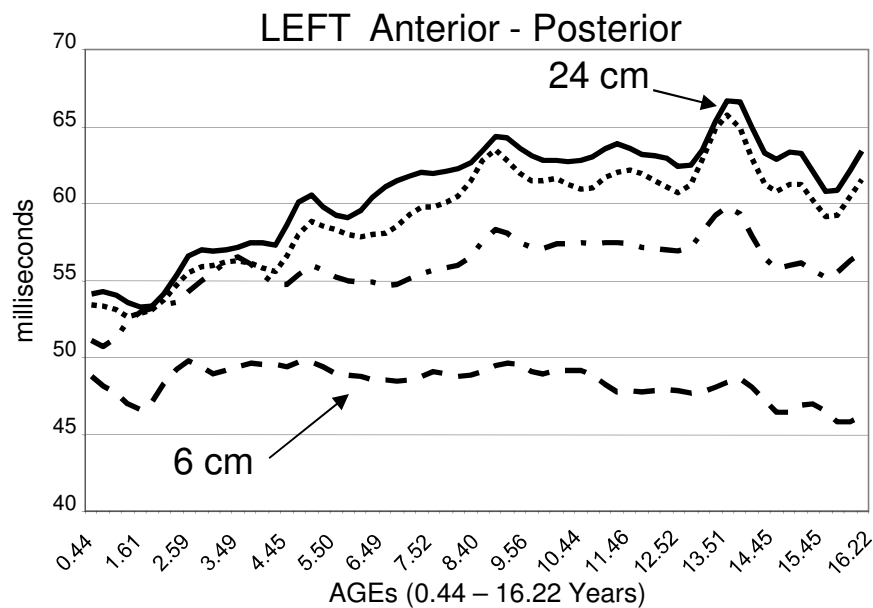

# Development of Phase Synchrony Interval

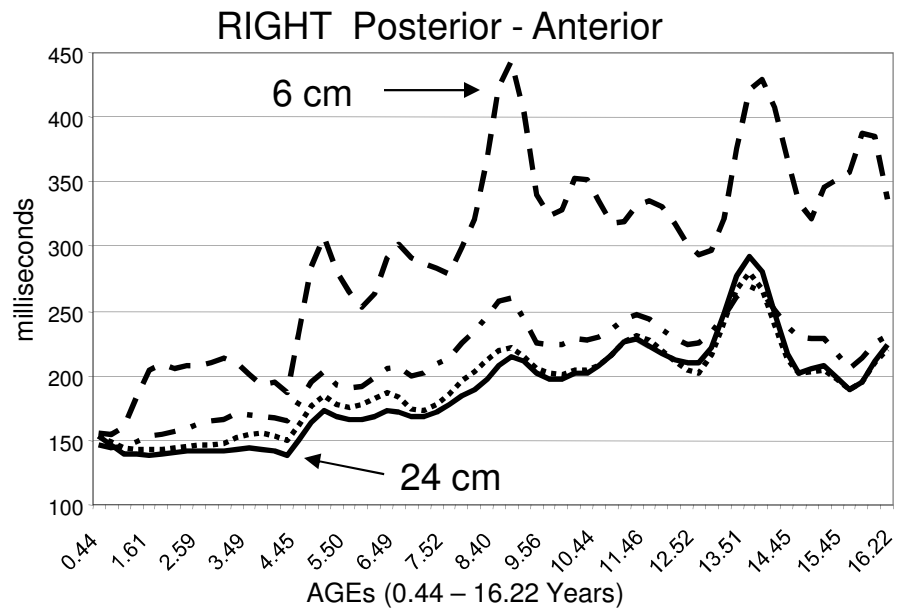
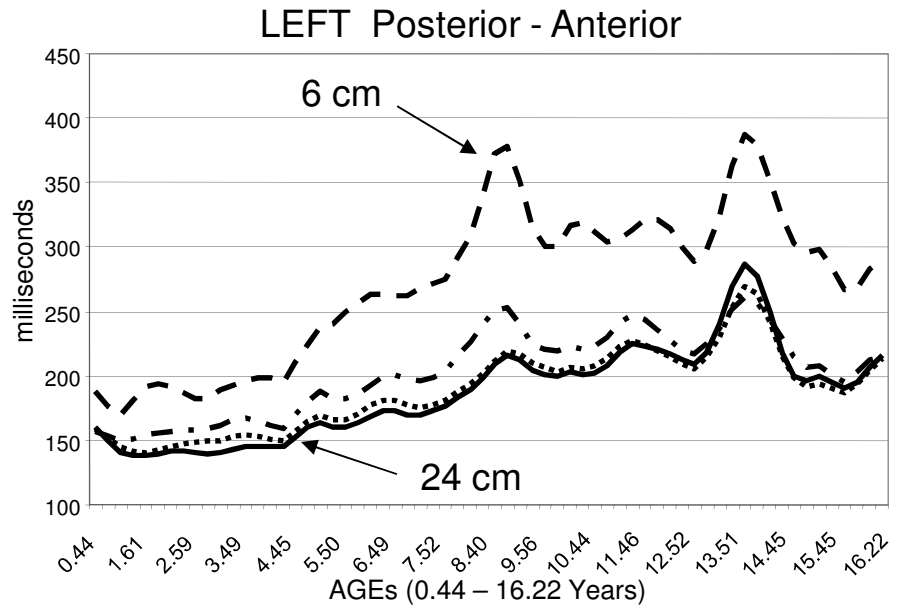
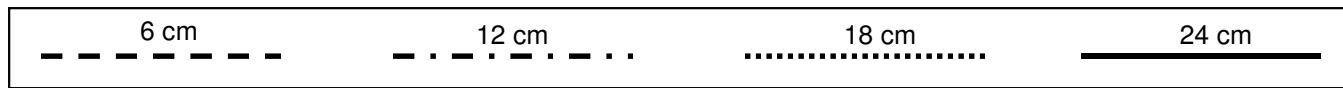
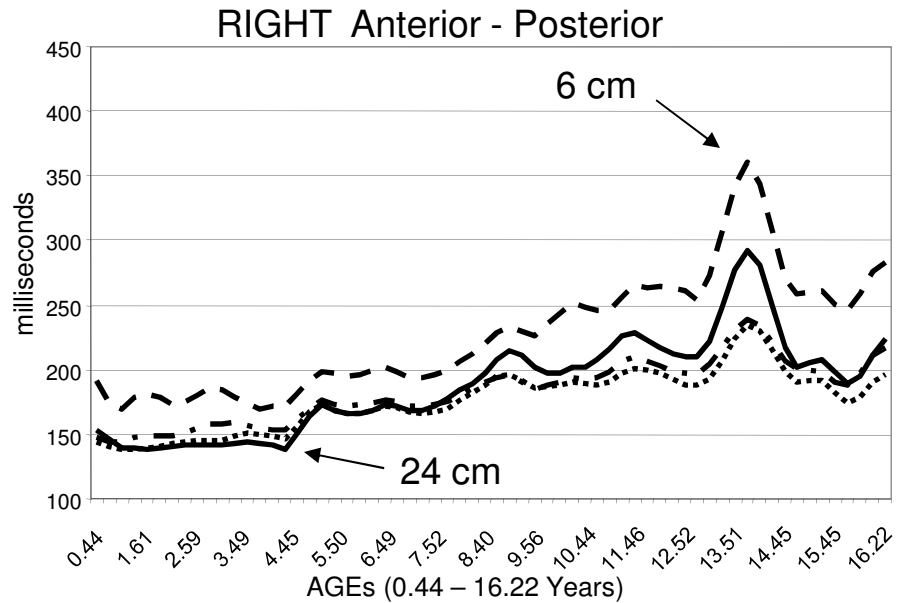
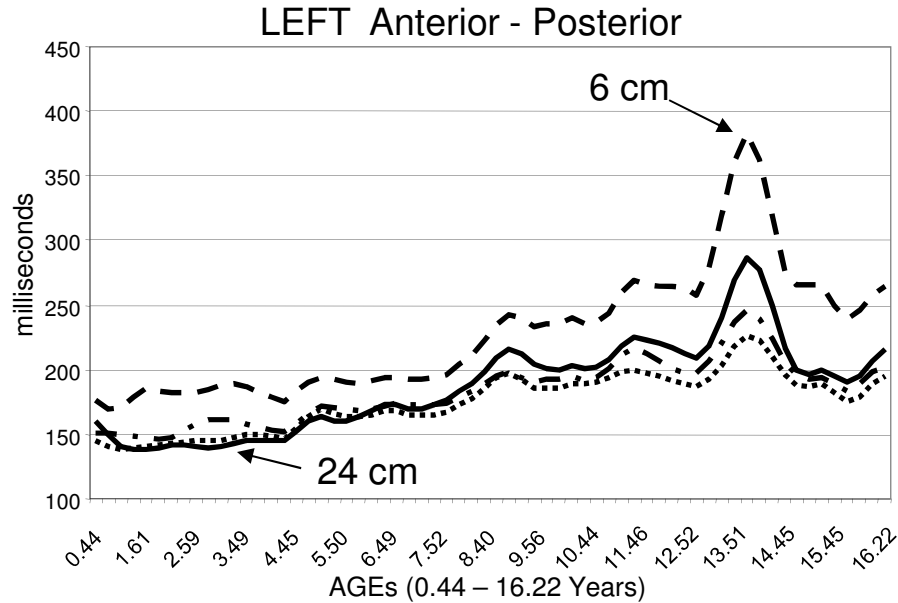

**Table V**  
**Correlations between Coherence and Phase Shift (Chaos)**  
**and Phase Synchrony (Stability)**

**Chaos**

**Stability**

<b>Coherence</b>	<b>- 0.547</b>	<b>0.863</b>
<b>Chaos</b>	<b>-----</b>	<b>- 0.386</b>
<b>Stability</b>	<b>- 0.386</b>	<b>-----</b>

**Published in NeuroImage – NeuroImage, 42(4): 1639-1653, 2008.**

**INTELLIGENCE AND EEG PHASE RESET:  
A TWO COMPARTMENTAL MODEL OF PHASE SHIFT AND LOCK**

**Thatcher, R. W. 1,2, North, D. M.1, and Biver, C. J.1**

**EEG and Neuroimaging Laboratory, Applied Neuroscience Research Institute.  
St. Petersburg, Fl1 and Department of Neurology, University of South Florida  
College of Medicine, Tampa, Fl.2**

## Regressions & Correlations of Phase Shift Duration Short Distances (6 cm)

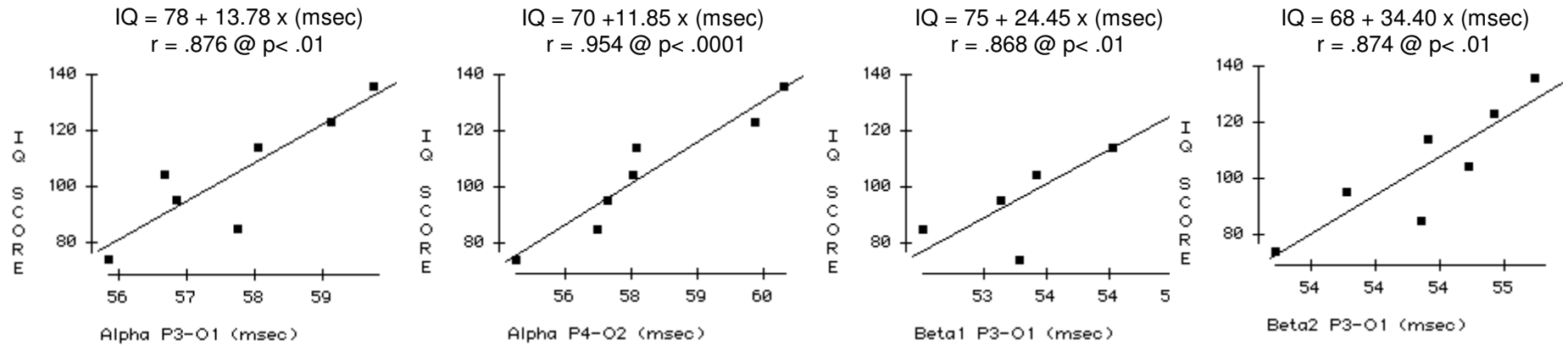

## Regressions & Correlations of Phase Locking Interval Short Distances (6 cm)

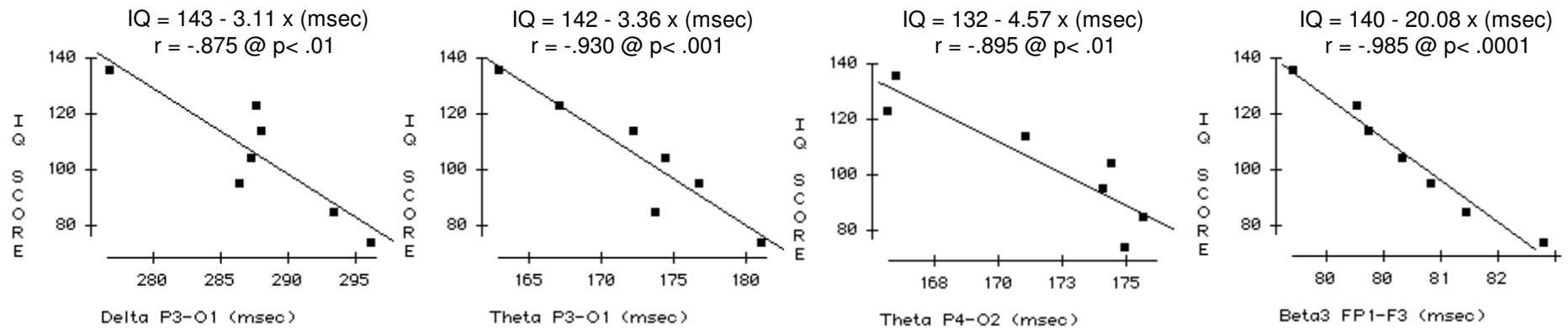

### Shift Duration

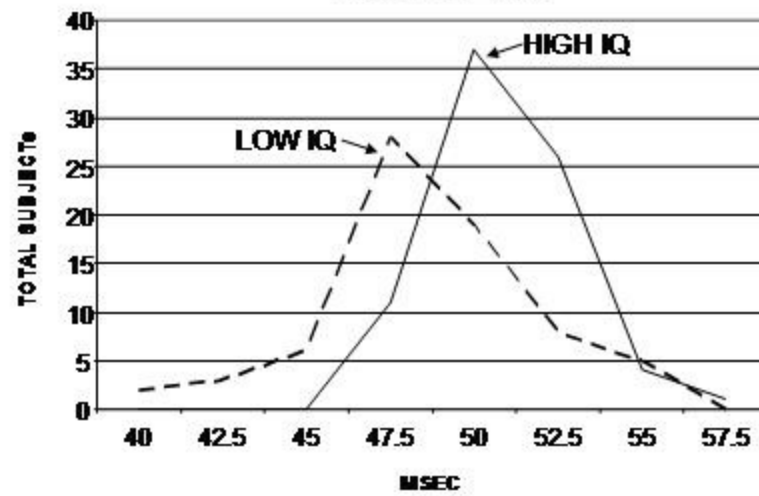

### Lock Duration

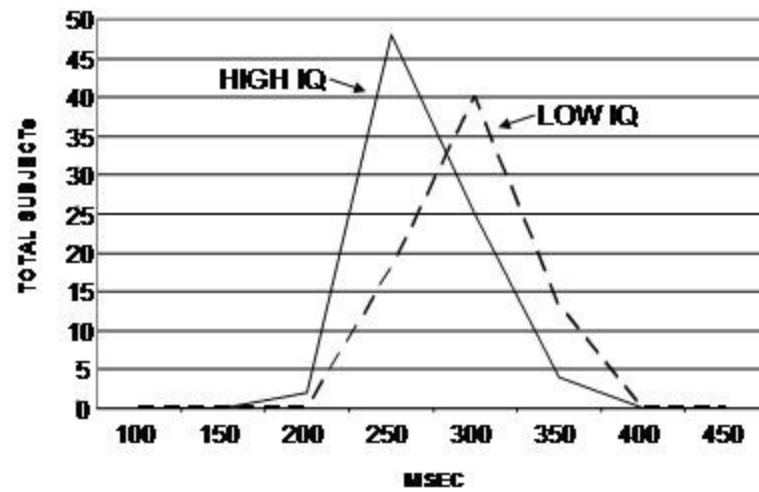

# Local Field Potential (LFP) Model of Phase Shift Duration and Full Scale I.Q.

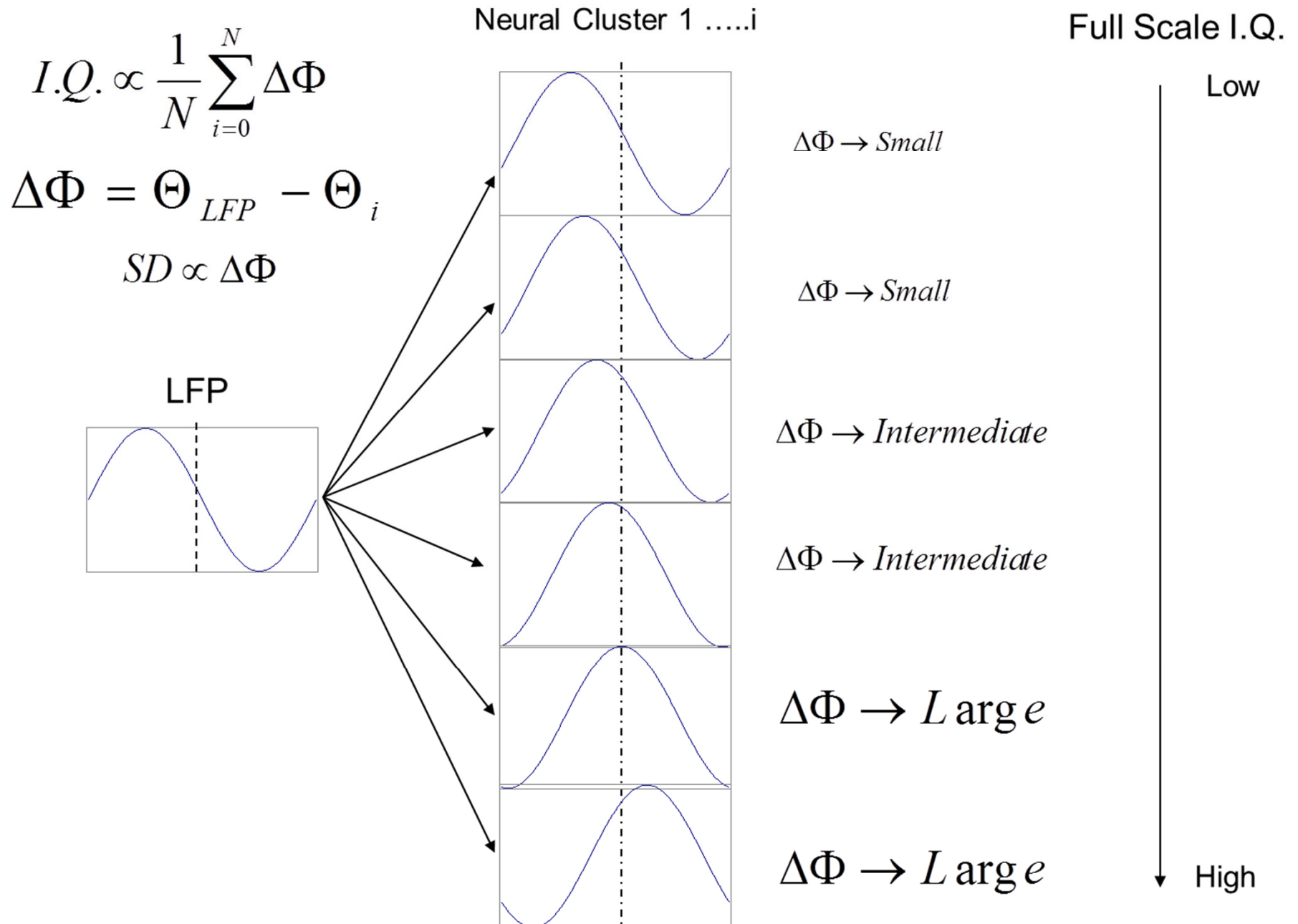

# Pyramidal Cell Model of EEG Phase Reset and Full Scale I.Q.

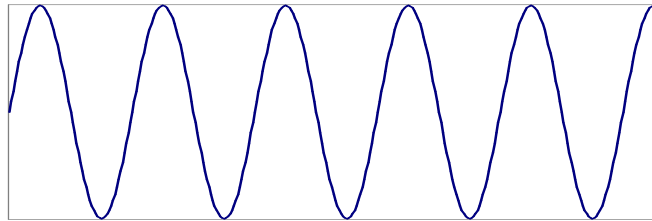

LFP

Distant EPSP  
Loop Connections LD

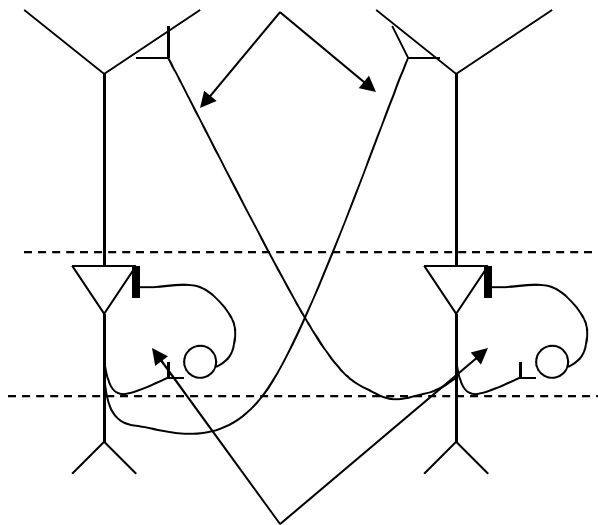

Average  
EPSP  
Duration

→ LD

Average  
 $\Delta\Phi = \Theta_{LFP} - \Theta_{Pref}$

→ SD

Local IPSP  
Connections  
SD

Phase Lock Duration (LD)

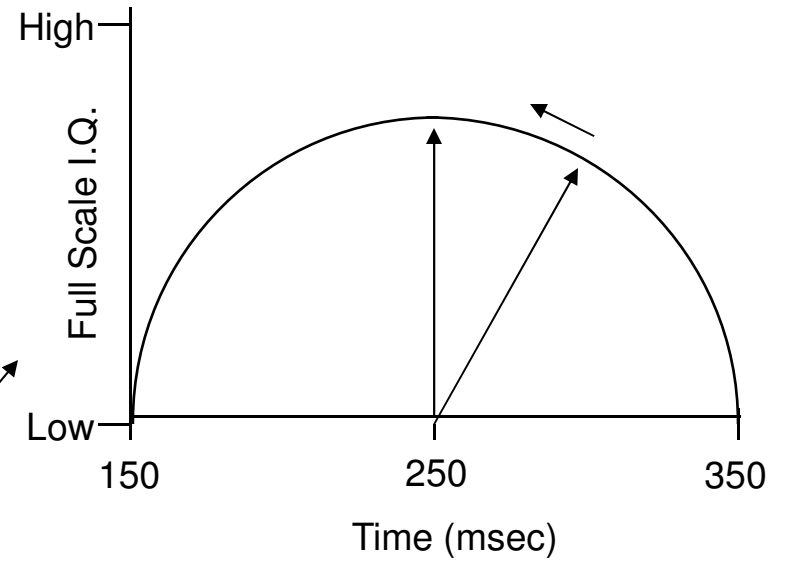

Phase Shift Duration (SD)

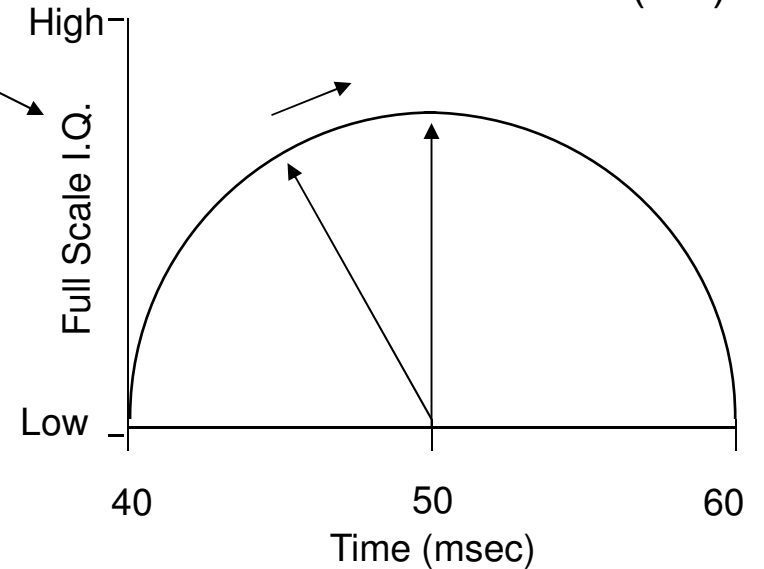

**AUTISM AND EEG PHASE RESET:  
A UNIFIED THEORY OF DEFICIENT GABA MEDIATED INHIBITION IN  
THALAMO-CORTICAL CONNECTIONS**

**Thatcher, R. W. 1,2, Phillip DeFina<sup>2</sup>, James Neurbrander<sup>2</sup>, North, D. M.<sup>1</sup>, and  
Biver, C. J.<sup>1</sup>**

**EEG and Neuroimaging Laboratory, Applied Neuroscience Research  
Institute., St. Petersburg, FL<sup>1</sup> and the International Brain Research  
Foundation, Menlo Park, NJ<sup>2</sup>**

### Alpha1 Shift Duration Short Distances

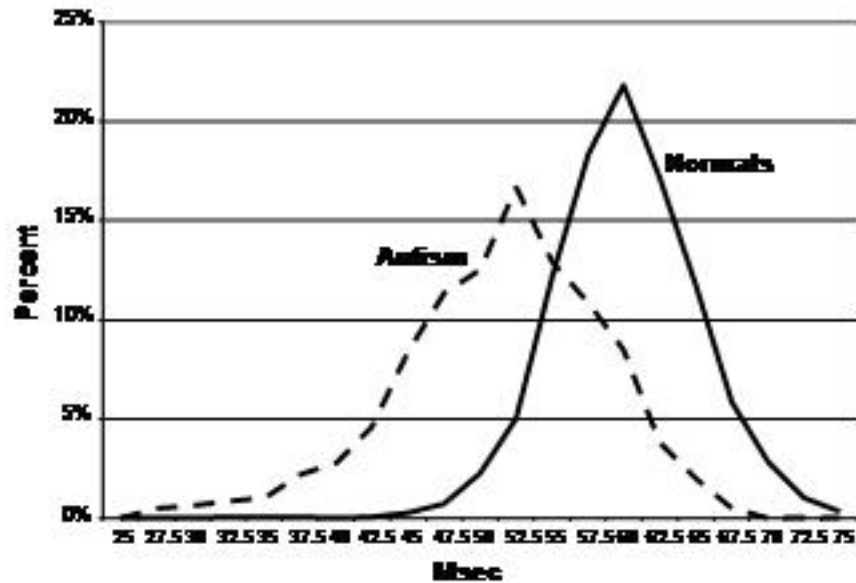

### Alpha2 Lock Duration Short Distances

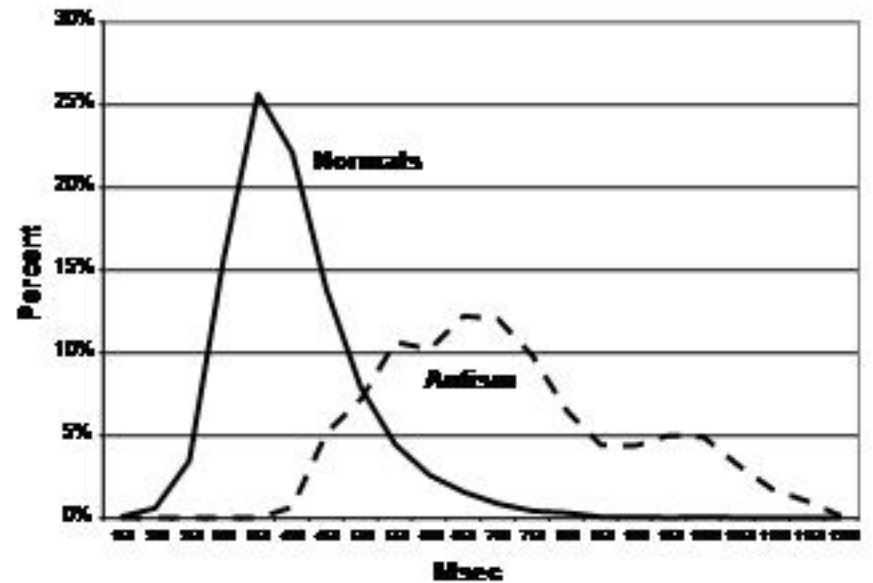

### Alpha1 Shift Duration Long Distances

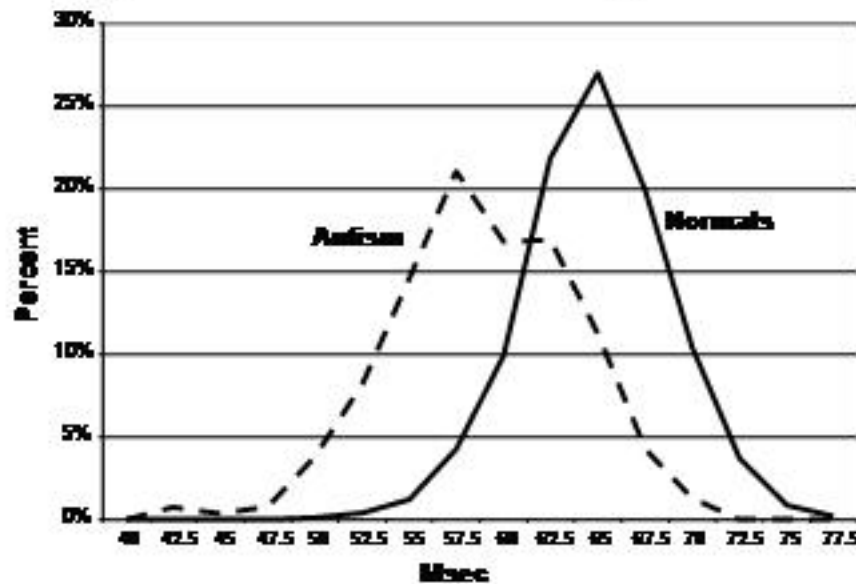

### Alpha2 Lock Duration Long Distances

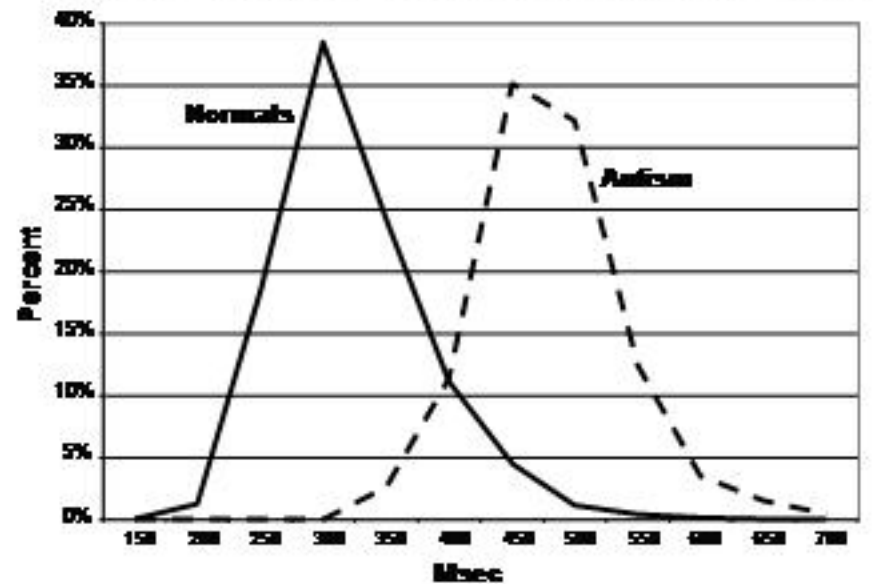

### Lock Duration Short Distances

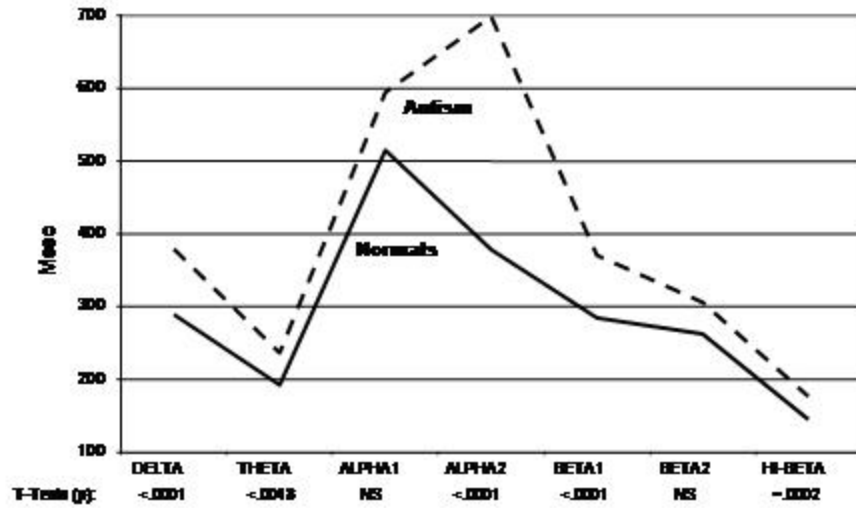

### Lock Duration Long Distances

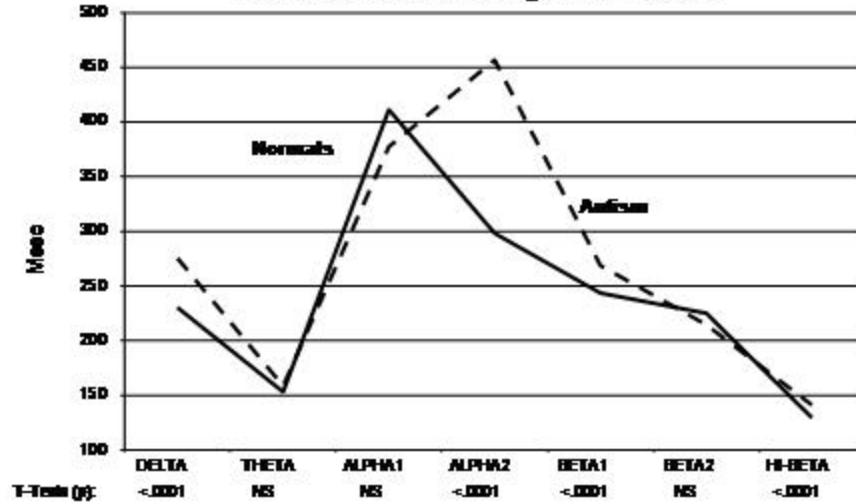

AUTISM - ALPHA2 - PHASE LOCK DURATION 6cm INTER-ELECTRODE DISTANCES

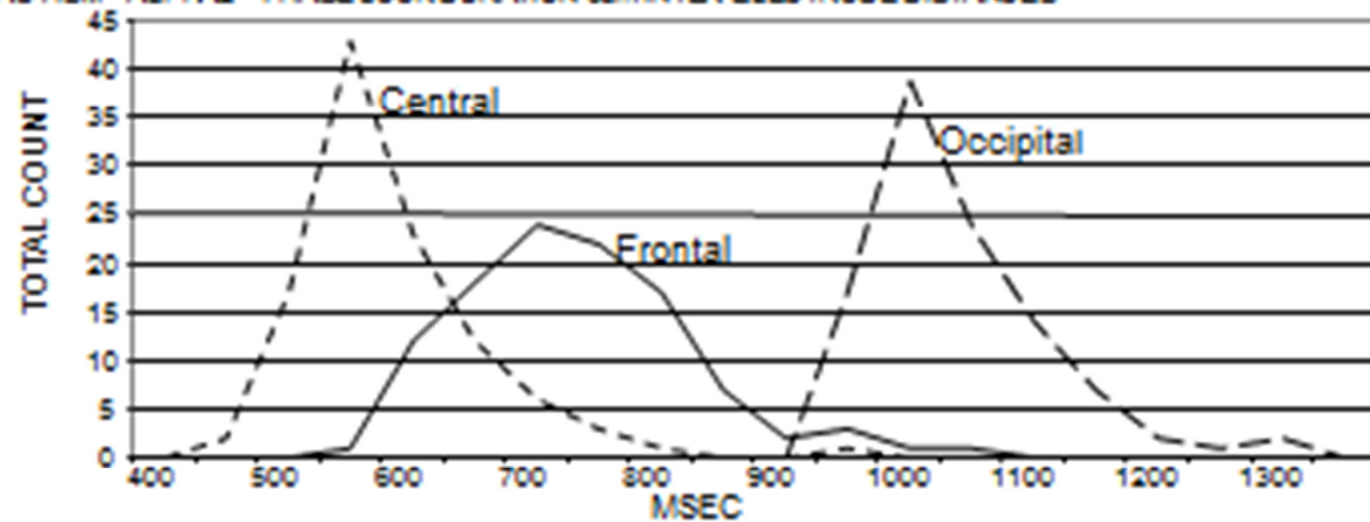

# **Cross-Frequency Phase Shift and Phase Lock**

**Note: ICA Obliterates Time & Phase Differences  
Between Channels and Cannot be Used  
for These Type of Analyses**

Neural code for Memory A

Neural code for Memory B

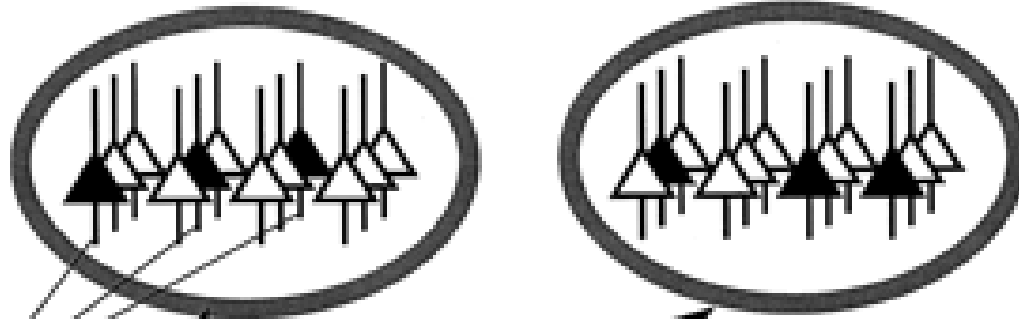

A memory is represented by a subset of pyramidal neurons firing in synchrony

Active memories are repeated each theta cycle

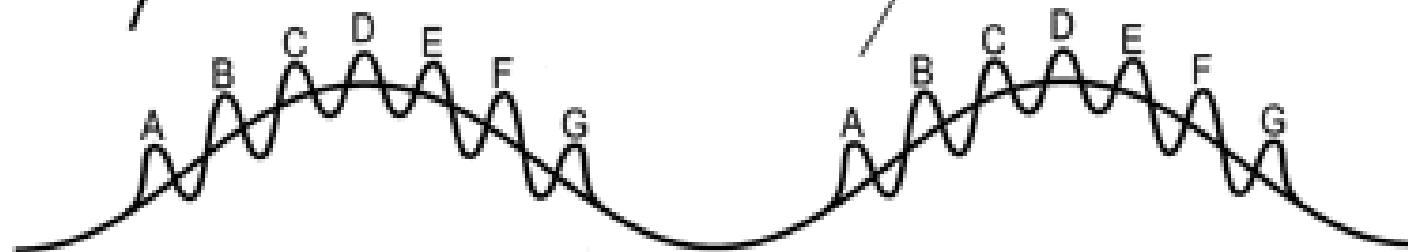

theta 4-10 Hz

gamma 20-80 Hz

dead time = d

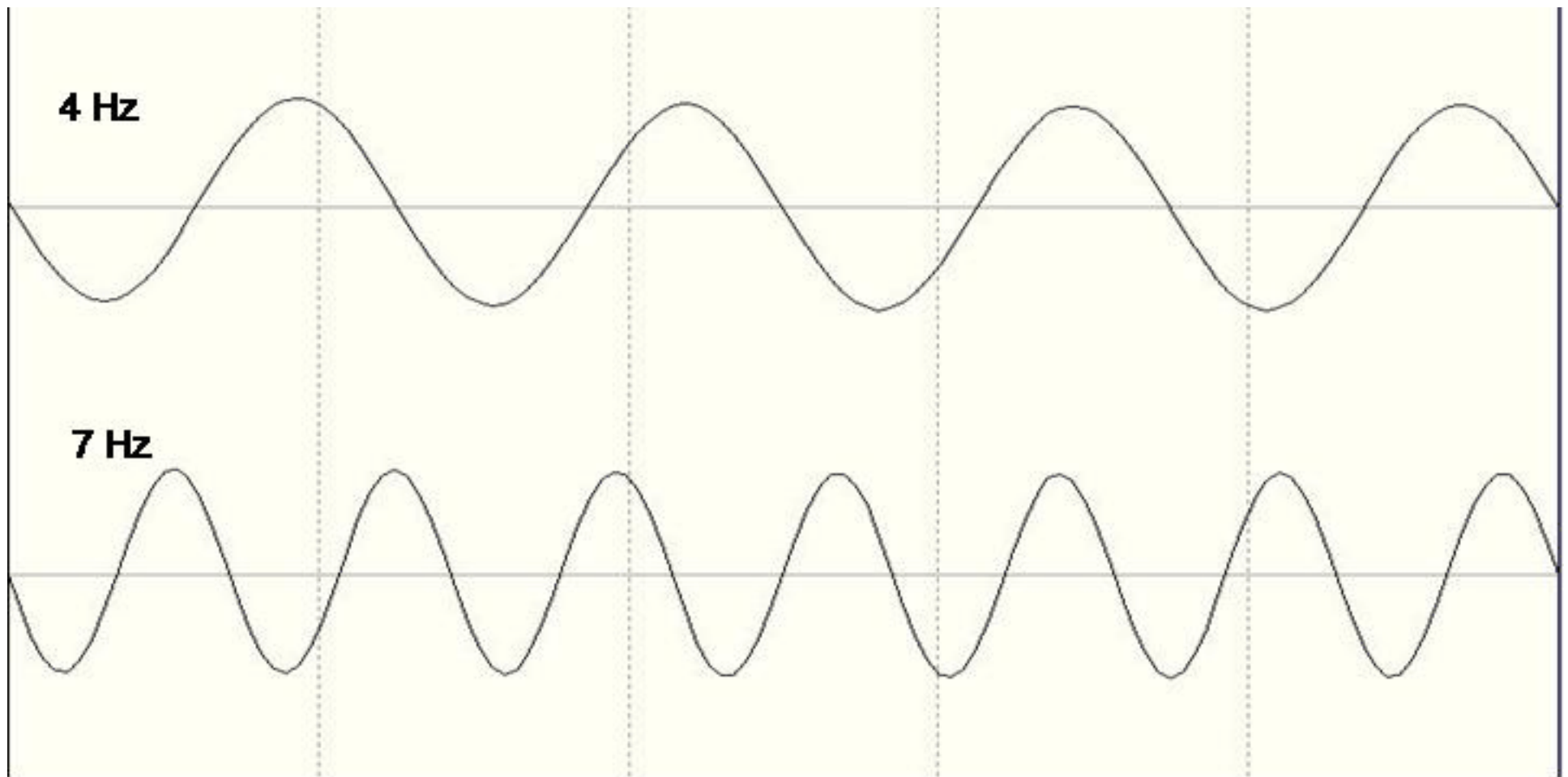

Time	$t_1$	$t_2$	$t_3$	$t_4$
Phase Diff	$196^{\circ}$	$406^{\circ}$	$616^{\circ}$	$826^{\circ}$
Differences of Differences		$210^{\circ}$	$210^{\circ}$	$210^{\circ}$ → Constant

$$1^{\text{st}} \text{ Derivative} = \frac{d^{\prime}(\theta_{f1} - \theta_{f2})}{dt} = \text{Const}$$

$$2^{\text{nd}} \text{ Derivative} = \frac{d^{\prime\prime}(\theta_{f1} - \theta_{f2})}{dt} = 0$$

### FP1 Cross-Frequency Phase Shift Duration

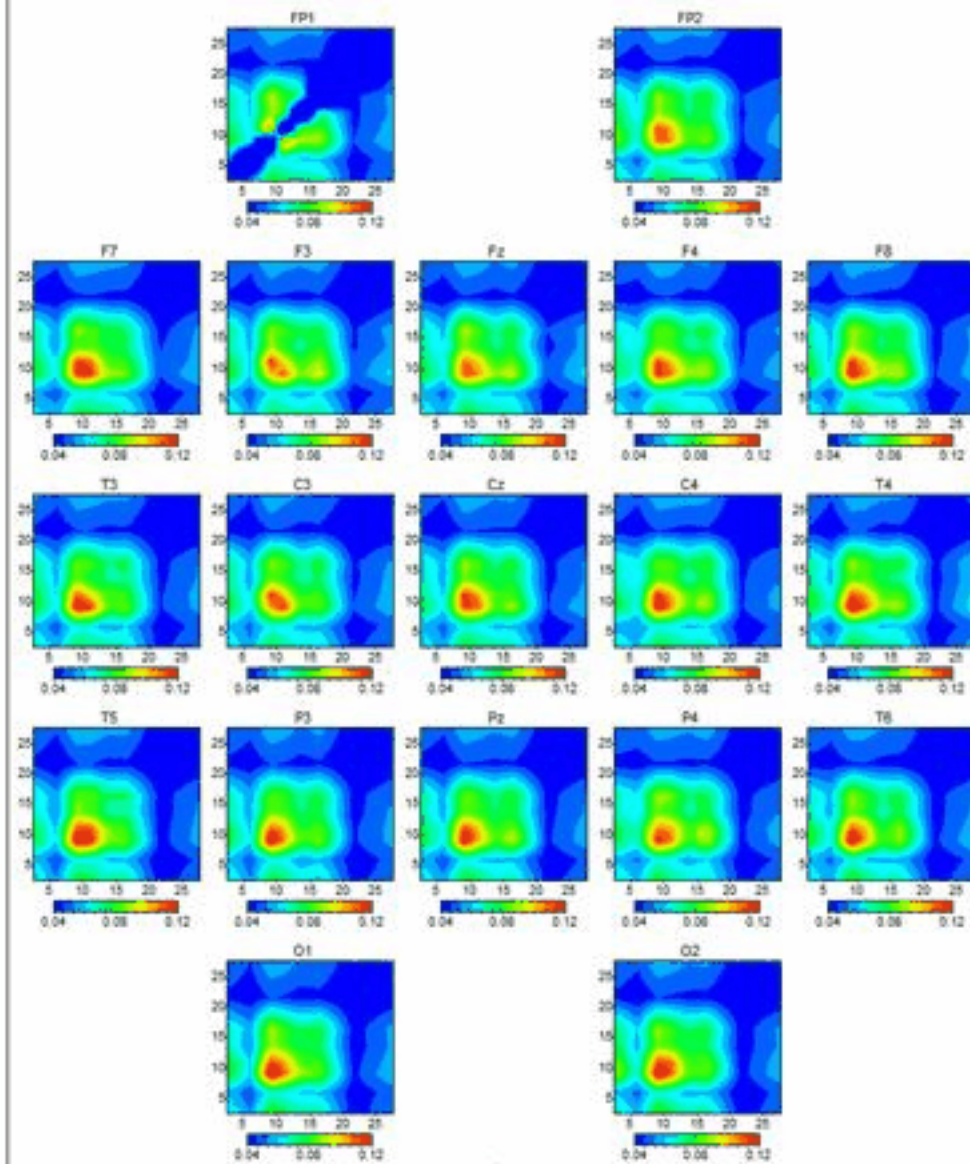

### FP1 Cross-Frequency Phase Lock Duration

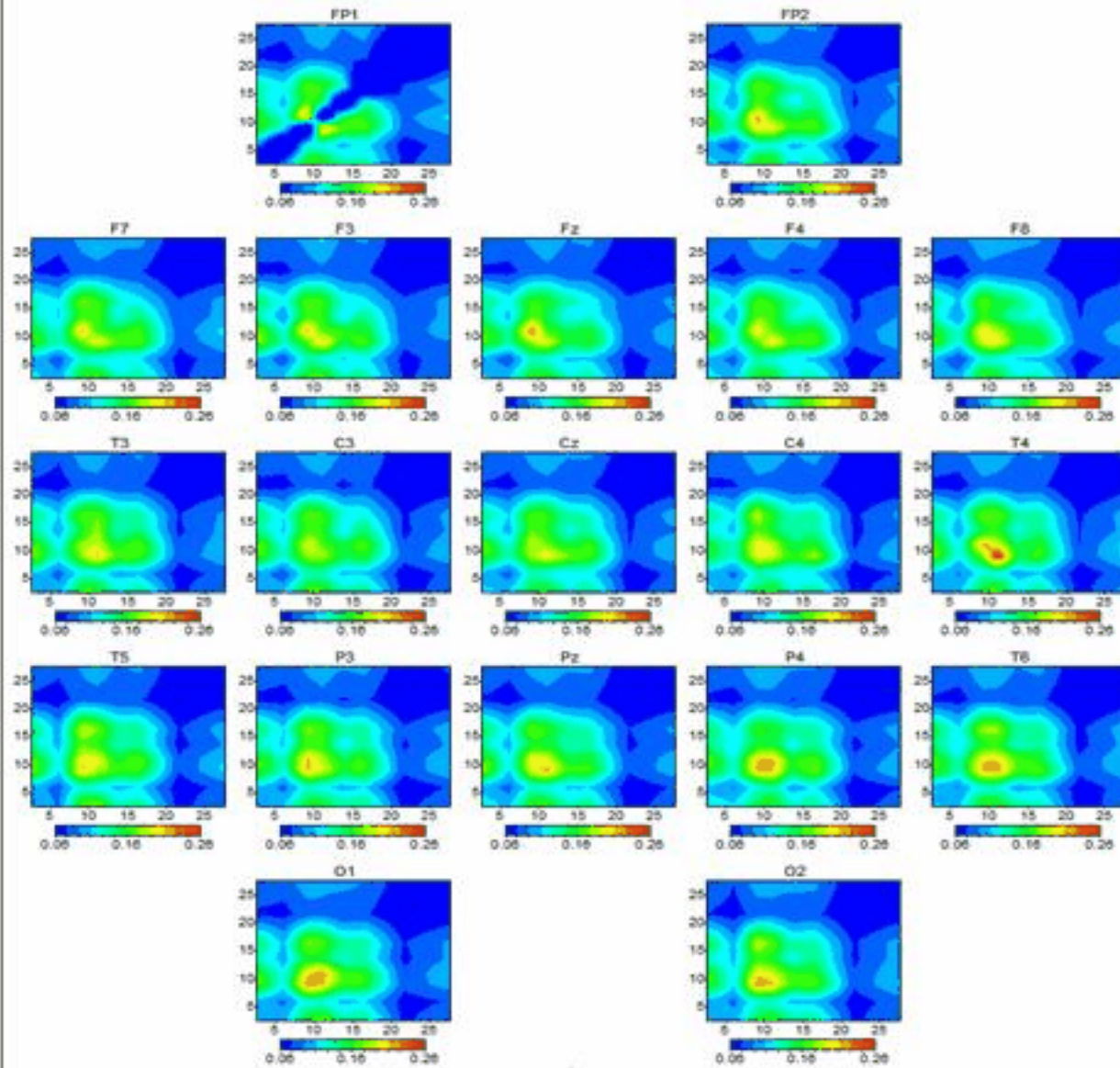

# **Electrical NeuroImaging of Functional Modules and Hubs as Measured by fMRI and PET**

**Phase Shift and Phase Lock Switch Dynamics that “Animate”  
Information Flow Within and Between Modules and Hubs**

# Brodmann Areas

**Frontal Lobe**  
Thinking, Planning,  
Motor execution,  
Executive Functions,  
Mood Control

**Temporal Lobe**  
language function and  
auditory perception  
involved in long term  
memory and emotion

**Anterior Cingulate Gyrus**  
Volitional movement, attention,  
long term memory

**Parietal Lobe**  
somatosensory perception integration  
of visual & somatospatial information

**Occipital Lobe**  
Visual perception &  
Spatial processing

**Posterior Cingulate**  
attention, long-term  
memory

**Parahippocampal Gyrus**  
Short-term memory, attention

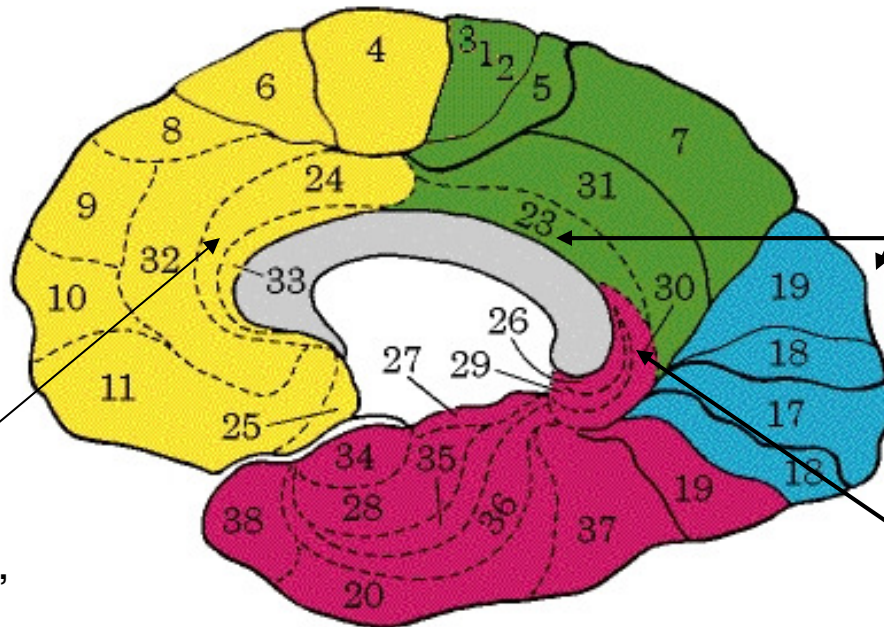
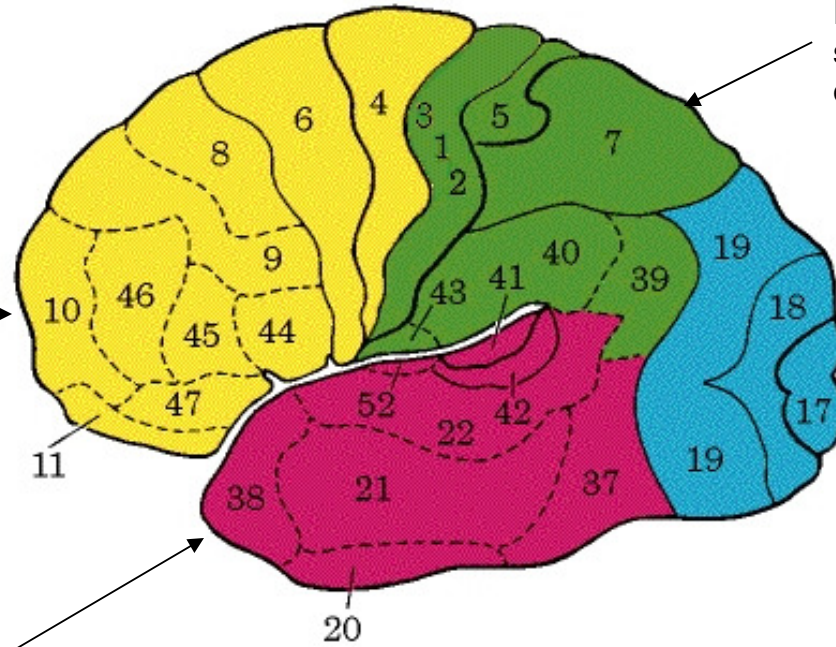

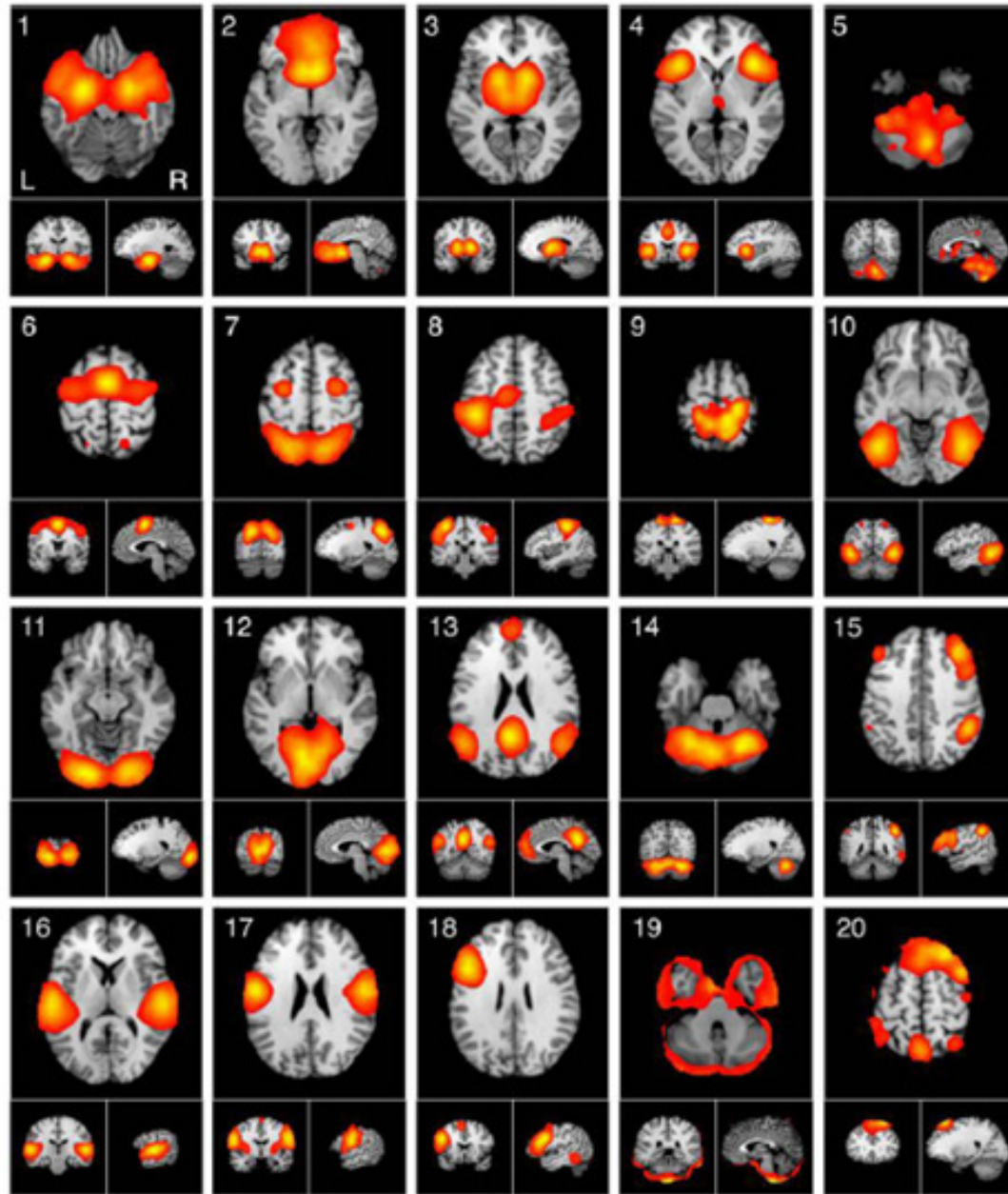

Laird et al (2011) summarized the various "intrinsic connectivity networks" or ICNs into eighteen specific groupings based upon 30,000 fMRI and PET studies

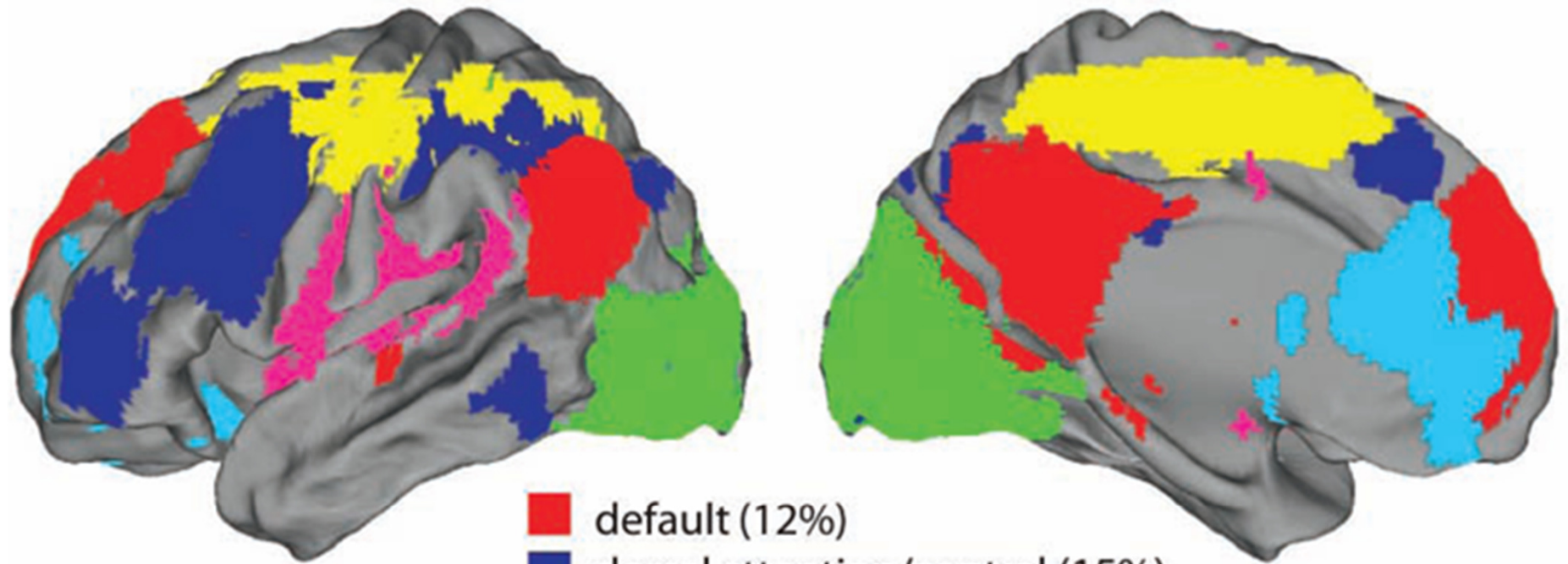

- default (12%)
- dorsal attention/control (15%)
- visual (16%)
- auditory/phonology (6%)
- motor (14%)
- self-referential (10%)

## Six Functional Modules as Measured by fMRI



Somato-  
motor

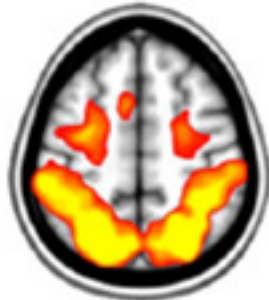

Dorsal  
attention



Control



Default  
mode



Auditory

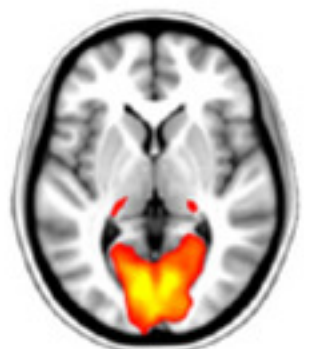

Visual

# Estimation of Cortical Source Current Density

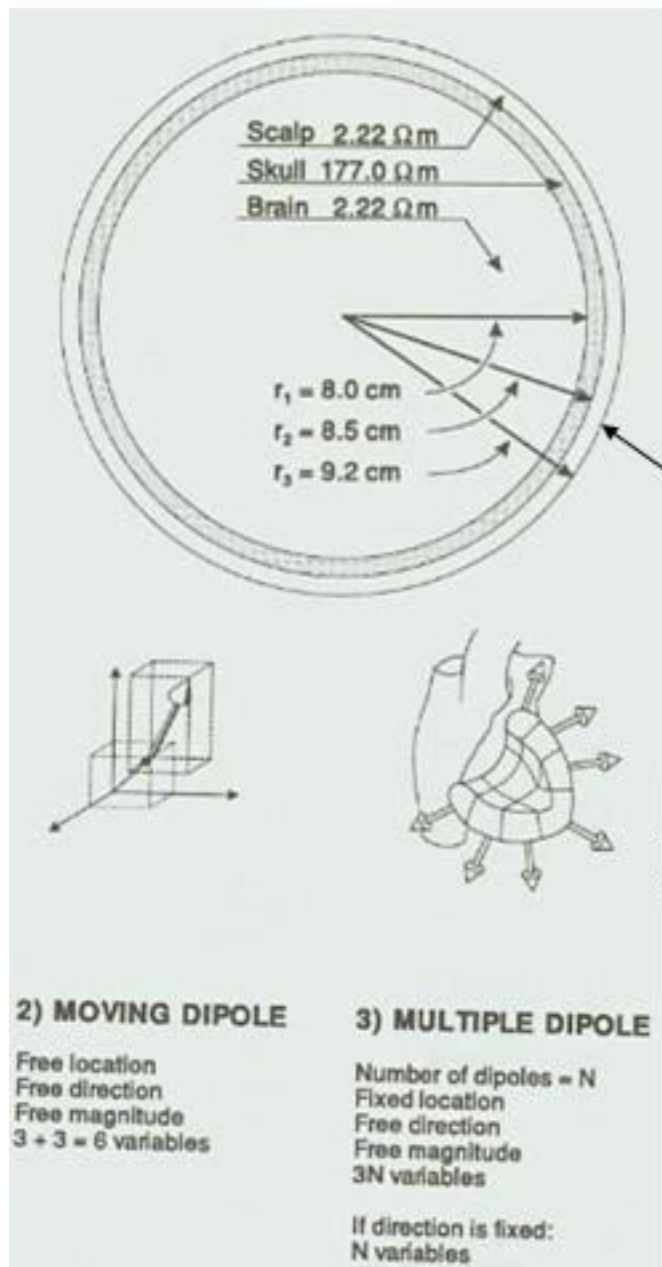

**Lead Field**

$$KJ = E + n$$

**Current Sources**

## Electrical Potentials - EEG

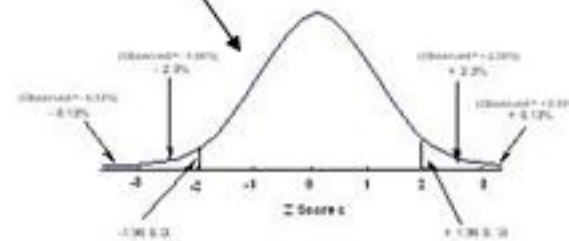
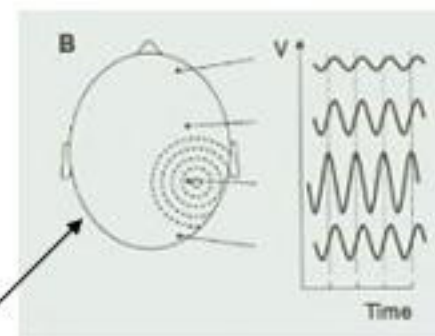

**Gaussian Distributed Noise**

# Electrical Neuroimaging and Cortical Source Localization

Horizontal, Sagittal & Coronal Views of a Single Slice

Cortical Surface Projection

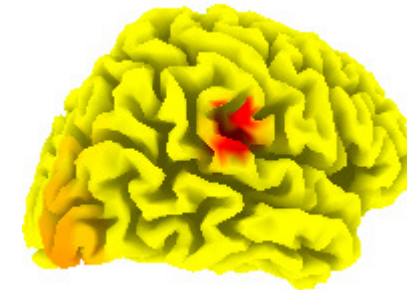
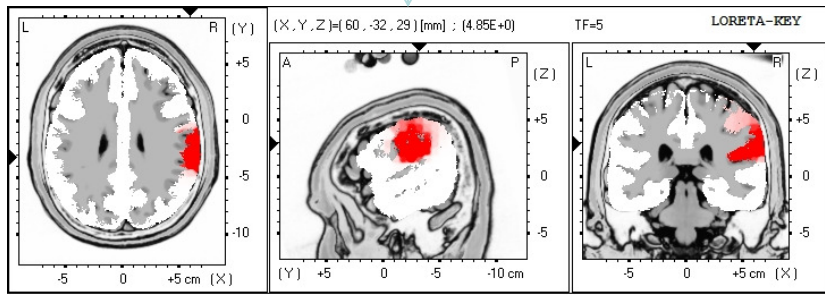

Tomographic Slice Display

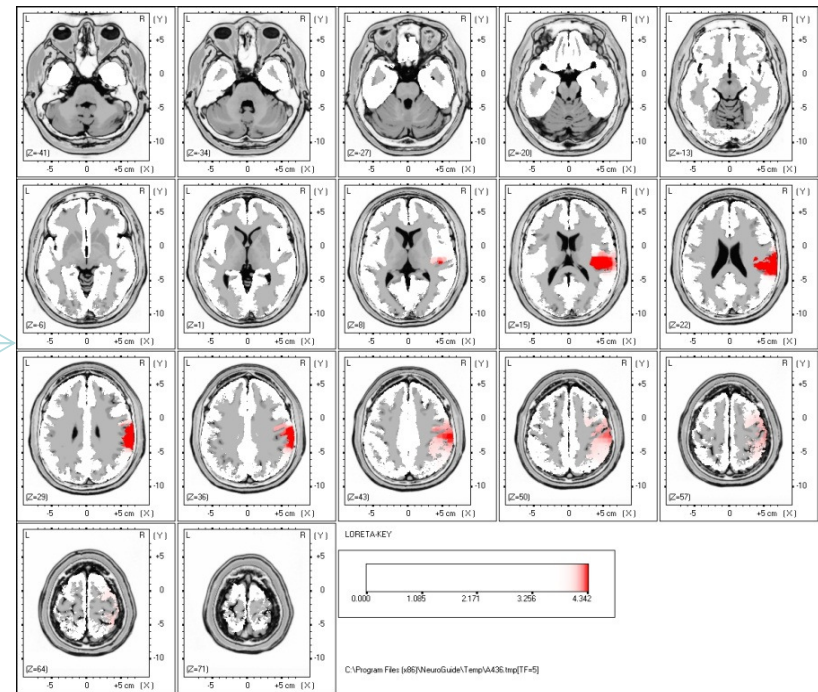
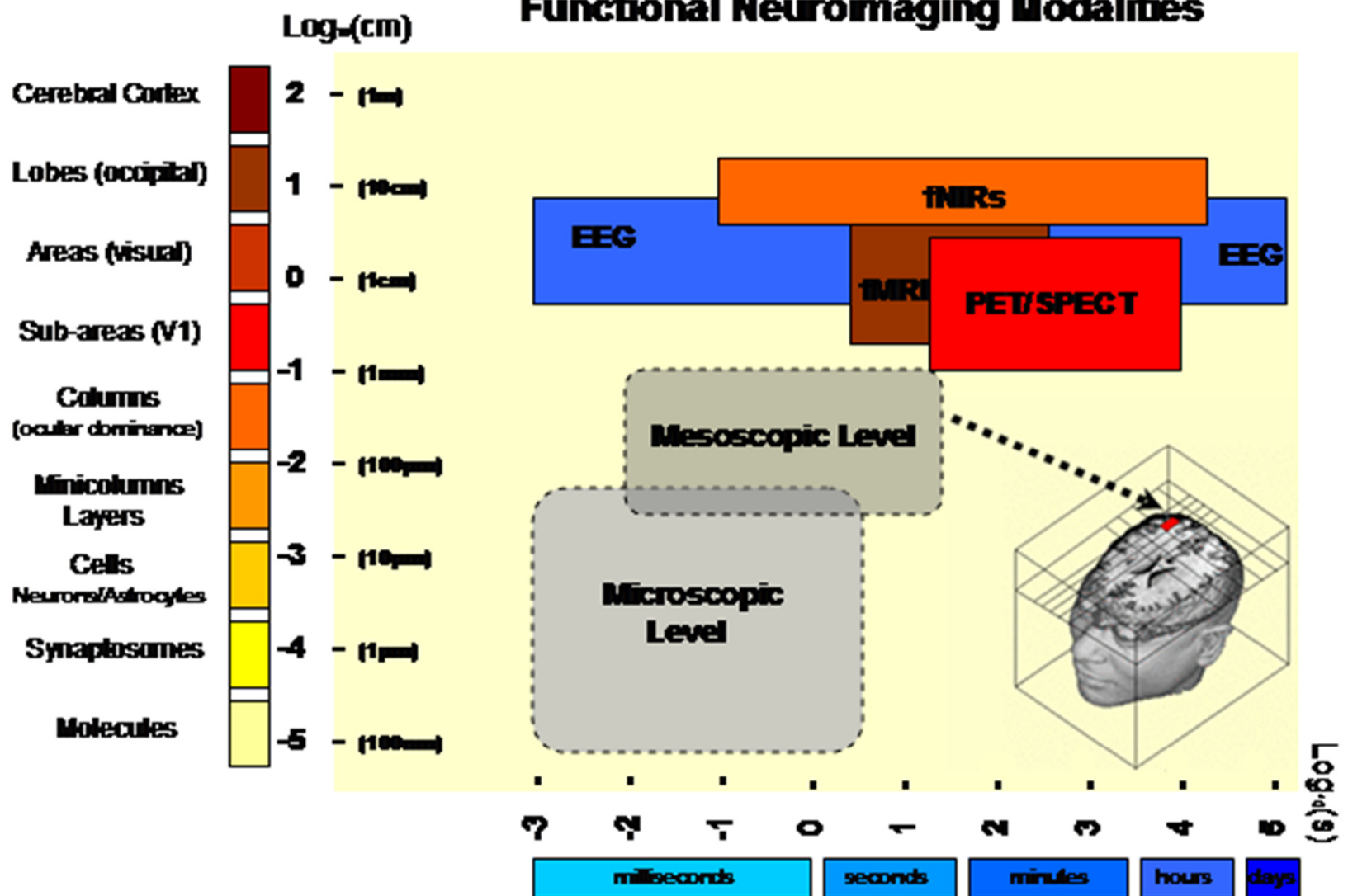

Table 5: Error measure EDI for the four inverse algorithms, with regularization, under four different noise levels: 25 dB, 15 dB, 10 dB and 5 dB. Each cell value gives the mean and standard deviation.

		EDI			
		Regularised			
SNR/dB		5	10	15	25
Layer					
<b>WMN</b>	Surface	3.46 ± 0.42	2.10 ± 0.28	1.34 ± 0.11	1.13 ± 0.03
	Middle	5.08 ± 0.50	3.94 ± 0.38	2.95 ± 0.21	2.40 ± 0.03
	Deep	5.91 ± 0.39	5.31 ± 0.36	4.61 ± 0.24	3.89 ± 0.15
<b>sLORETA</b>	Surface	0.99 ± 0.1	0.49 ± 0.08	0.11 ± 0.04	0.00 ± 0.00
	Middle	1.61 ± 0.13	0.84 ± 0.11	0.25 ± 0.07	0.00 ± 0.00
	Deep	1.79 ± 0.25	0.95 ± 0.16	0.39 ± 0.13	0.00 ± 0.00
<b>LORETA</b>	Surface	2.32 ± 0.08	2.18 ± 0.04	2.16 ± 0.03	2.21 ± 0.02
	Middle	1.51 ± 0.13	1.15 ± 0.08	0.95 ± 0.07	1.05 ± 0.06
	Deep	2.30 ± 0.21	1.81 ± 0.13	1.59 ± 0.11	1.53 ± 0.09
<b>SLF</b>	Surface	5.27 ± 0.30	4.50 ± 0.28	3.81 ± 0.20	2.98 ± 0.13
	Middle	4.53 ± 0.39	4.09 ± 0.35	3.50 ± 0.31	2.51 ± 0.15
	Deep	3.89 ± 0.55	3.70 ± 0.45	3.27 ± 0.48	1.73 ± 0.30

# Functional Neuroimaging Modalities



# **Electrical Neuroimaging – Assessment and Treatment**

## **Advantages of Electrical Neuroimaging**

- 1- Spatial Resolution – 1 cm to 3 cm**
- 2- Temporal Resolution – 1 msec**
- 3- Imaging of Current Sources**
- 4- Imaging of Network Connections**
- 5- Integration with DTI & fMRI (Brodmann Areas)**
- 6- Inexpensive (\$10,000 vs \$3,000,000)**
- 7- Dry Electrodes & Wireless Caps**
- 8- Portable**
- 9- Integration with Smart Phones & Tablets**
- 10- Can Assess & Treat in Real-Time<sup>1</sup>**



# LORETA Coherence

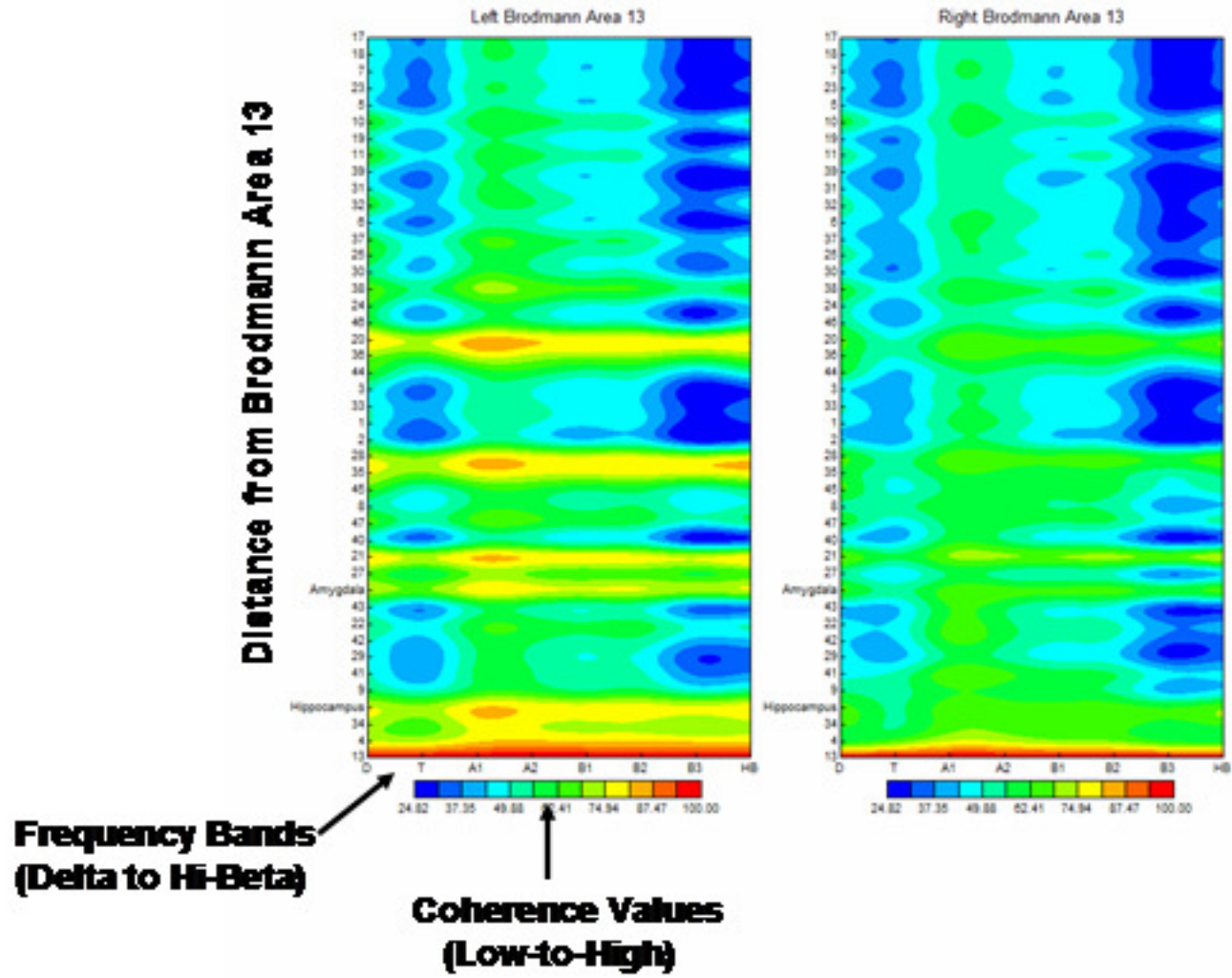

# LORETA Absolute Phase

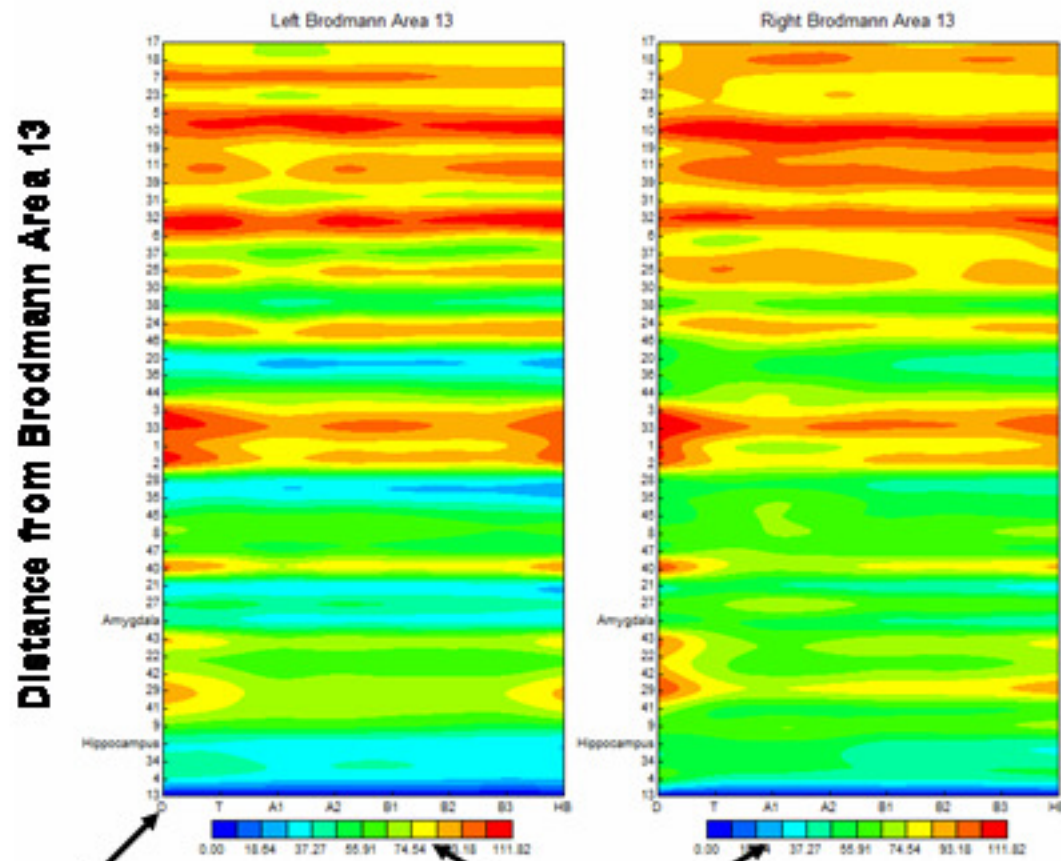

**Distance from Brodmann Area 13**

**Frequency Bands  
(Delta to Hi-Beta)**

**Phase Difference (Deg)  
(short to long differences)**

## Graph Theory and Neural Topology

- 1- A Node is the principle unit of a network in which nodes are connected (linked) to other *nodes*,
- 2- A Network consists of a number of nodes connected by links. Nodes are also called *vertices*.
- 3- A link is a connection between two nodes in the network. Links are also referred to as *edges* or simply *network connections*. *Axons are the links between neurons*.
- 4- The degree of a node is the number of nearest neighbors to which a node is connected. The mean degree of the network is the mean of the individual degrees of all nodes in the network.
- 5- Modules are clusters of neurons with high density of nearest neighbors and are high degree nodes.
- 6- Hubs are regions that link distinct clusters or modules. Provincial hubs are hub regions that are highly connected within one module and connector hubs are hub regions that link multiple modules.
- 7- A scale-free network is where the distribution of node number follows a power law.
- 8- A specific pattern of links or connections defines the network's *Topology*.

Small world models emphasize the intermediate position of total regularity and randomness where the small world model while containing random connections involves a small set of preferred long distance connections.

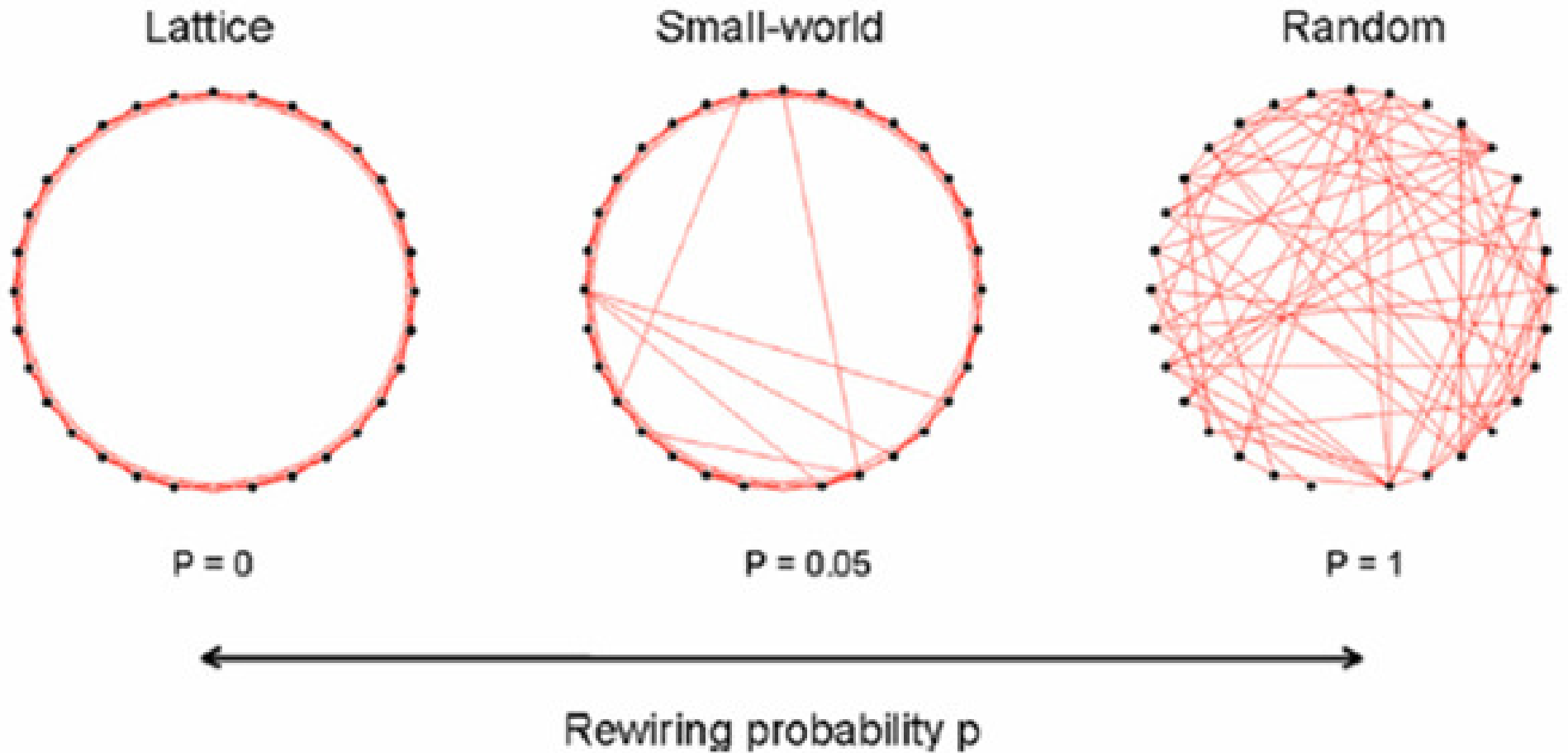

# Noisy Ionic Channels, Action Potentials and Stochastic Resonance

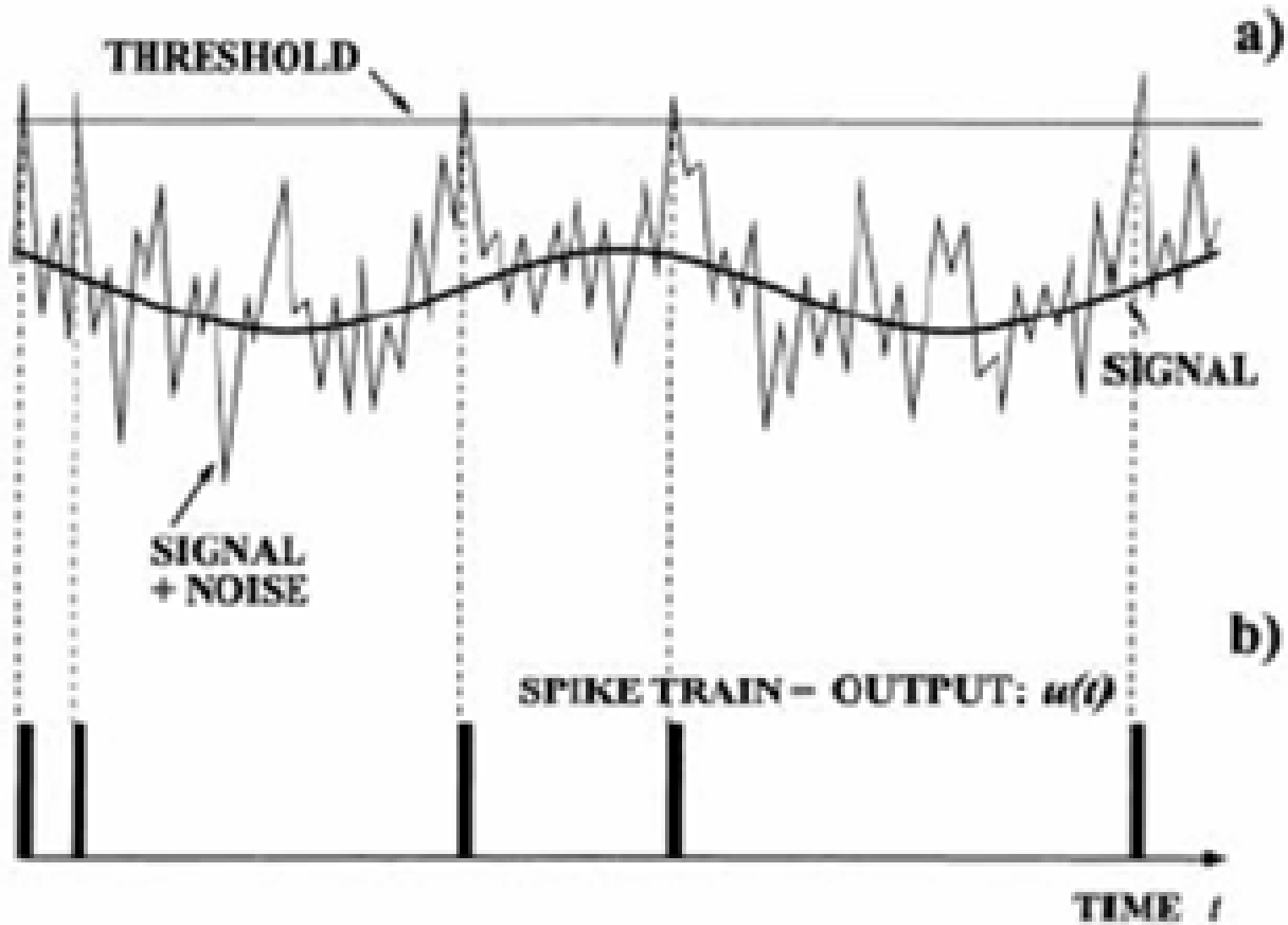

The 'Small-World' models are considered to be the best balance of these opposing factors.

**Benefit:** Increased brain size. Enlarging size by adding more neurons increases processing capacity.

**Trade-offs:** Neurons consume a lot of energy. And as brains get bigger the axons or “wires” that connect neurons have to become longer, which makes them slower.

**Benefit:** Increase interconnectedness. Adding more links between distant neurons enables brain parts to communicate better.

**Trade-offs:** The added wiring eats up energy and takes up space.

**Benefit:** Increase signaling speed is achieved by making axons thicker.

**Trade-offs:** Thicker axons consume more energy and take up more space than thinner ones do.

**Benefit:** Pack more neurons in the existing space. Achievable by shrinking neurons or axons or both.

**Trade-offs:** If axons or neurons get too small, they tend to fire randomly ([stochastic resonance](#)).

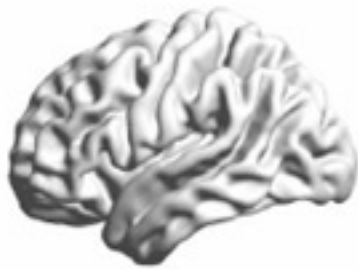

1) Brain Surface

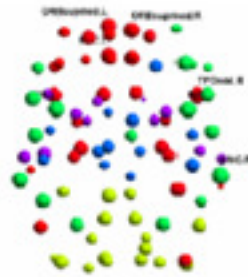

2) Nodes

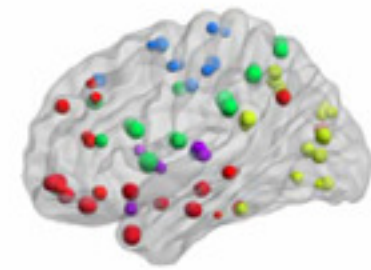

3) Surface & Nodes

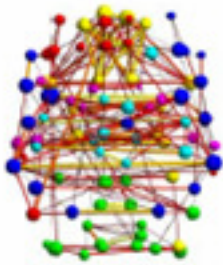

4) Nodes & Edges

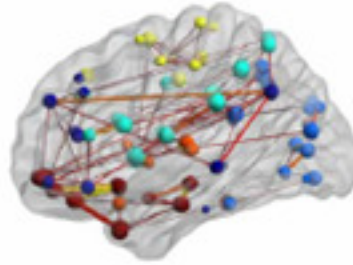

5) Surface, Nodes & Edges

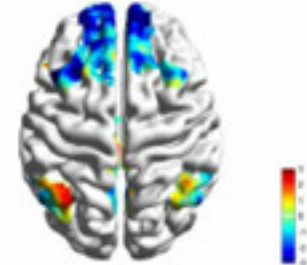

6) Surface mapping

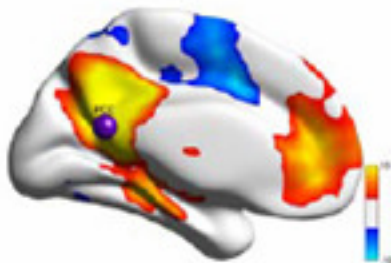

7) Surface mapping & node

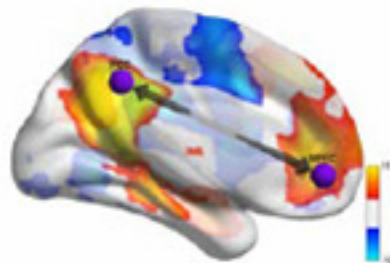

8) Surface mapping with node & edge



9) ROI in Volume

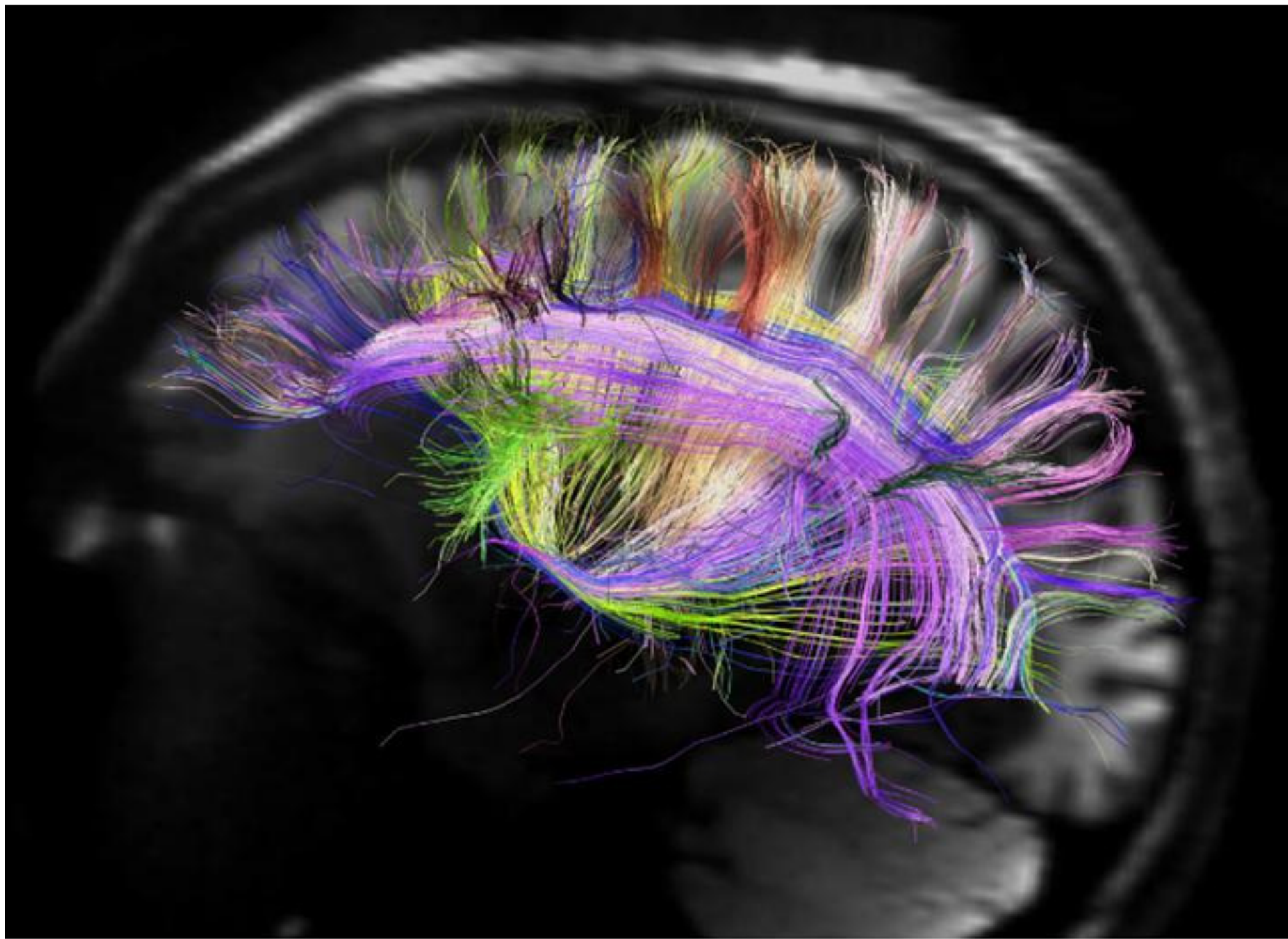

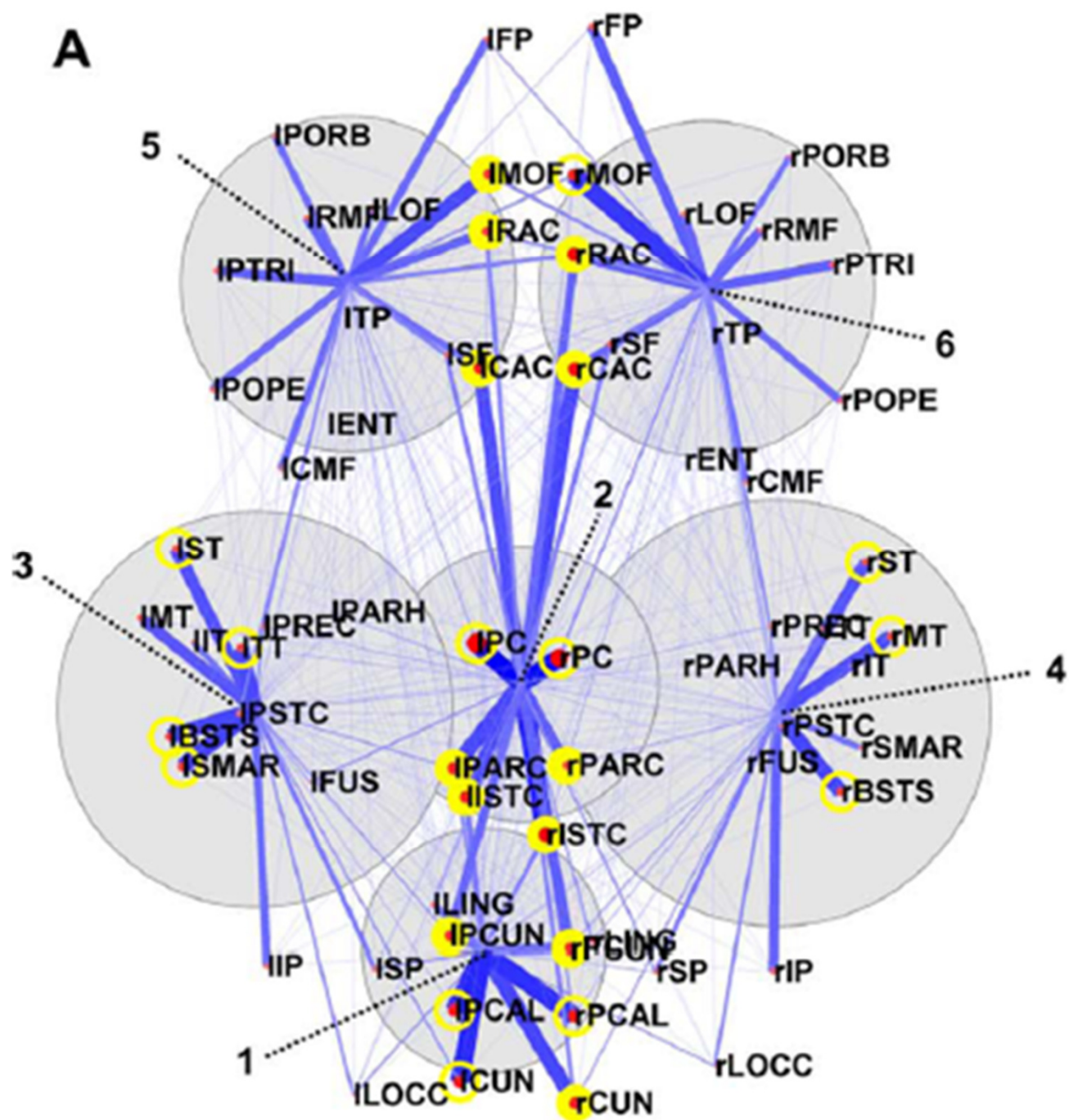
**A**

# Correlations Between EEG Neuroimaging and Diffusion Spectral Imaging (DTI)

Hagmann et al. Moduless

**MOD 1**

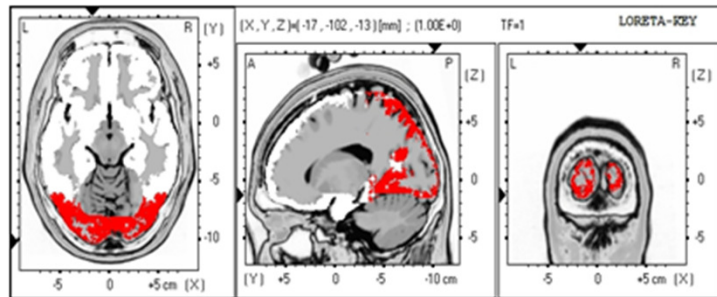

**MOD 2**

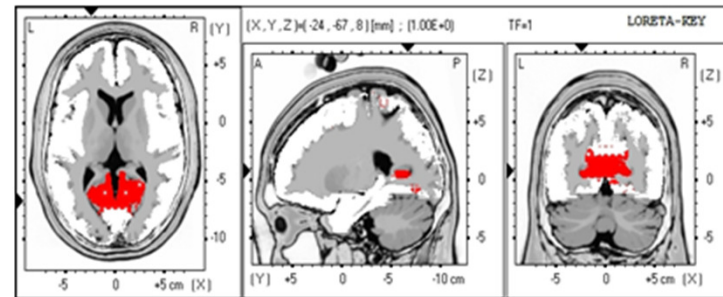

**MOD 3**

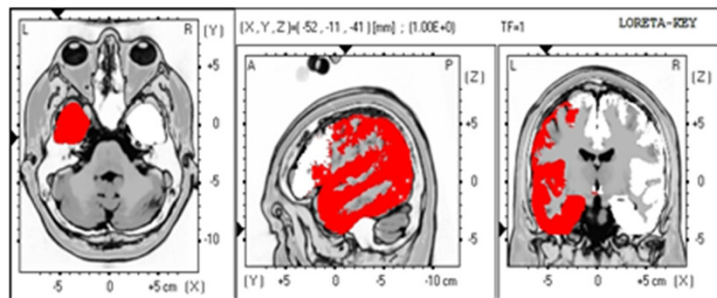

**MOD 4**

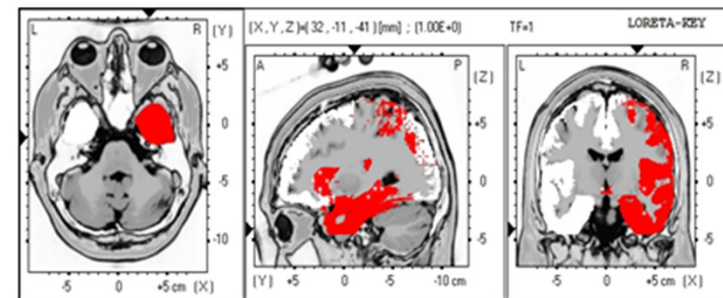

**MOD 5**

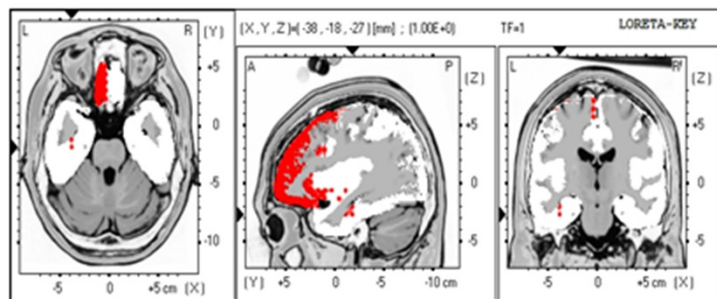

**MOD 6**

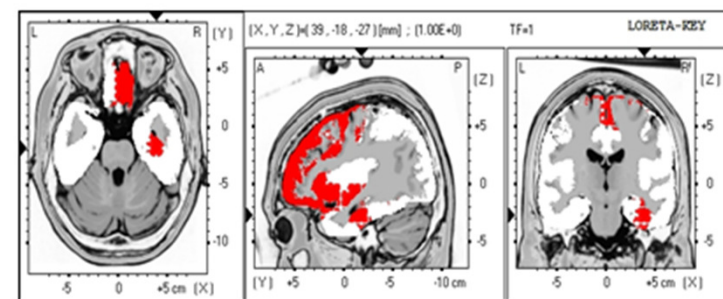

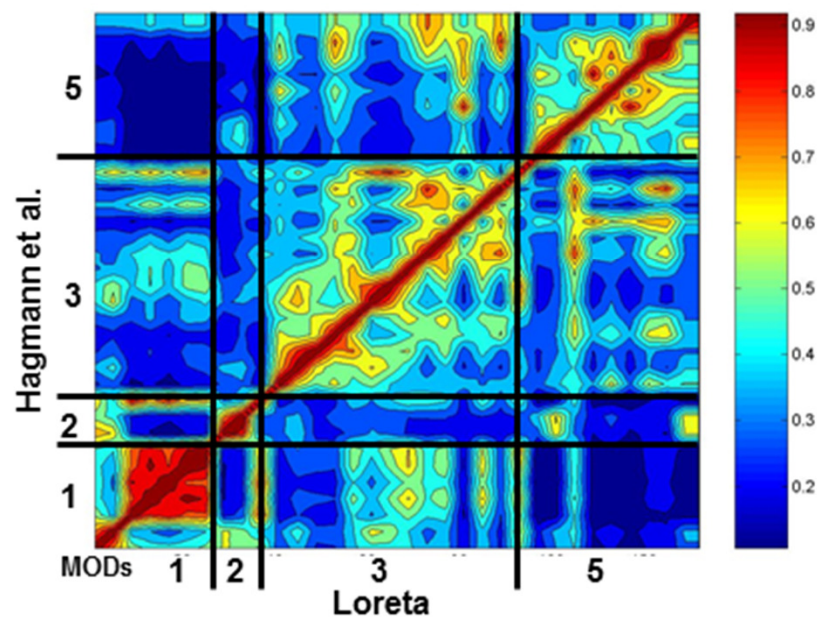
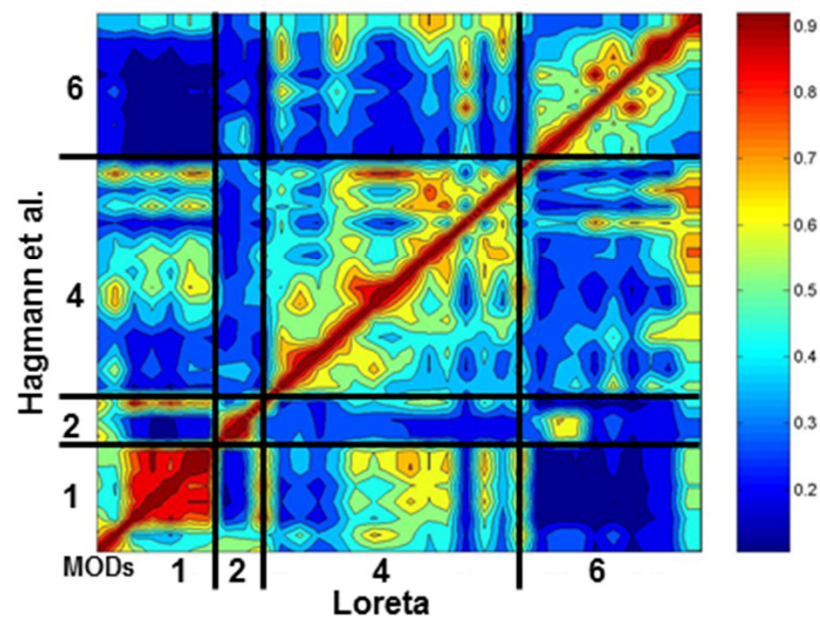
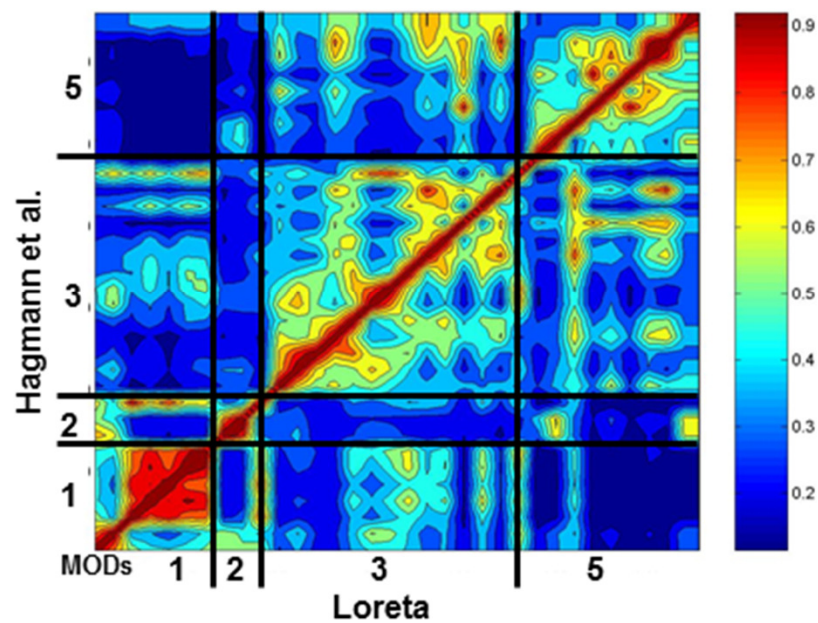
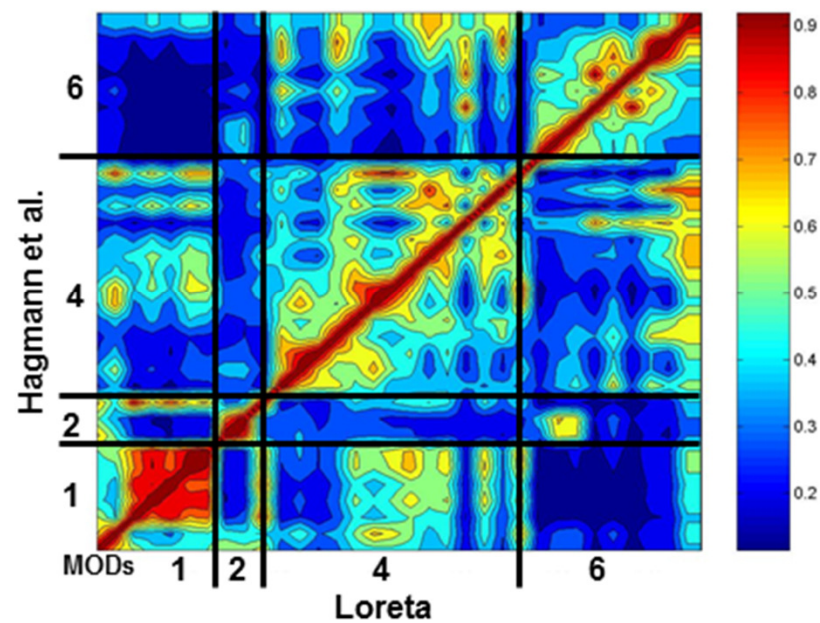
**EC\_LEFT****EC\_RIGHT****EO\_LEFT****EO\_RIGHT**

# Spatial Heterogeneity of Source Correlations

Cuneus  
62.75 mm

Y-Axis - Ordered Distance mm

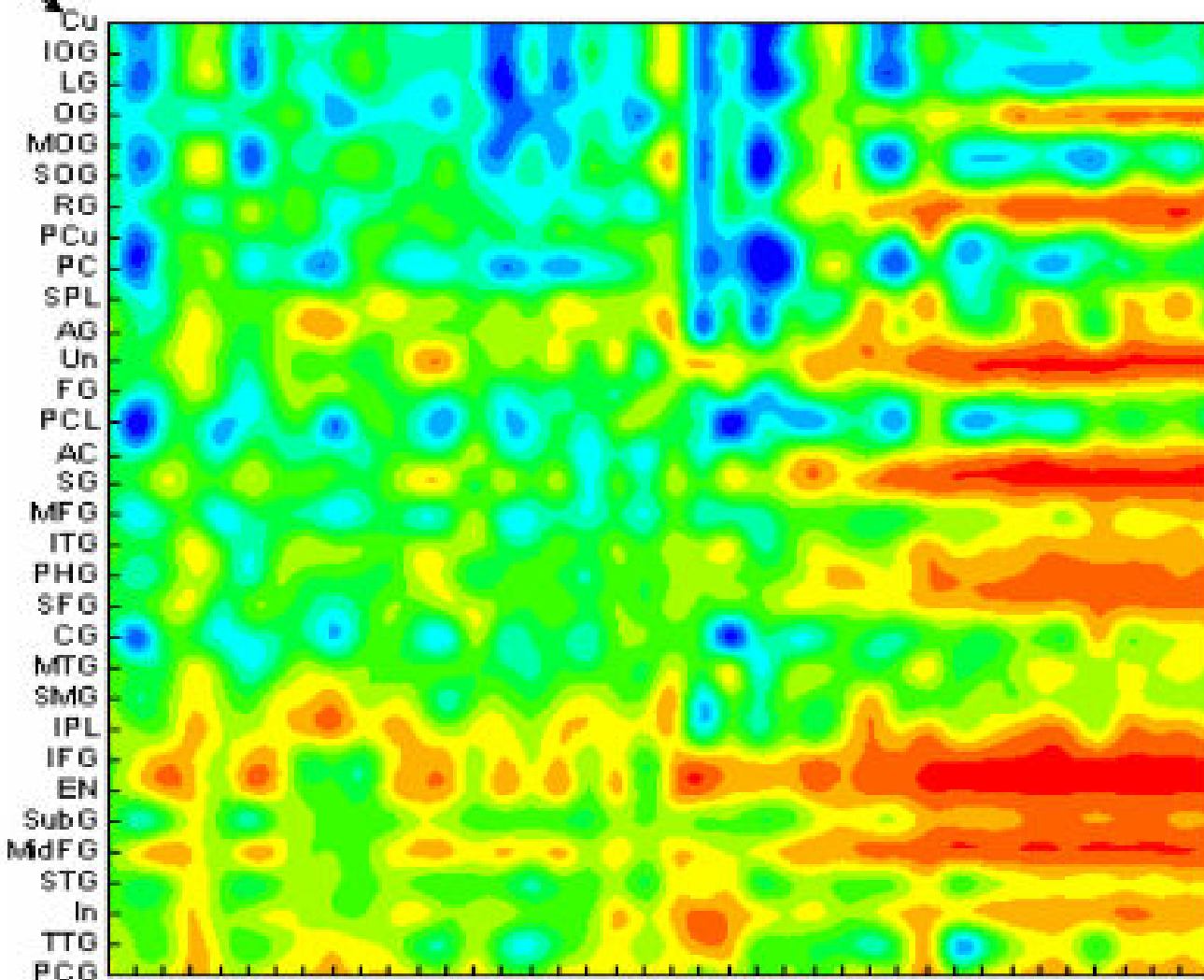

Post Central  
Gyrus 0 mm

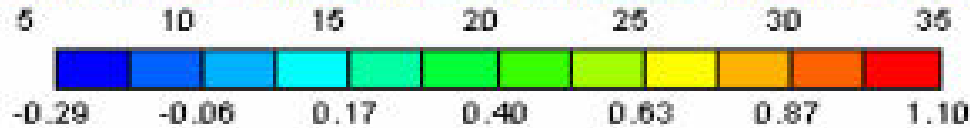

Z-Axis - LORETA Source Correlations

X-Axis  
Frequency 1 to 40 Hz

Hypothesized  
'U' Shaped  
Connections

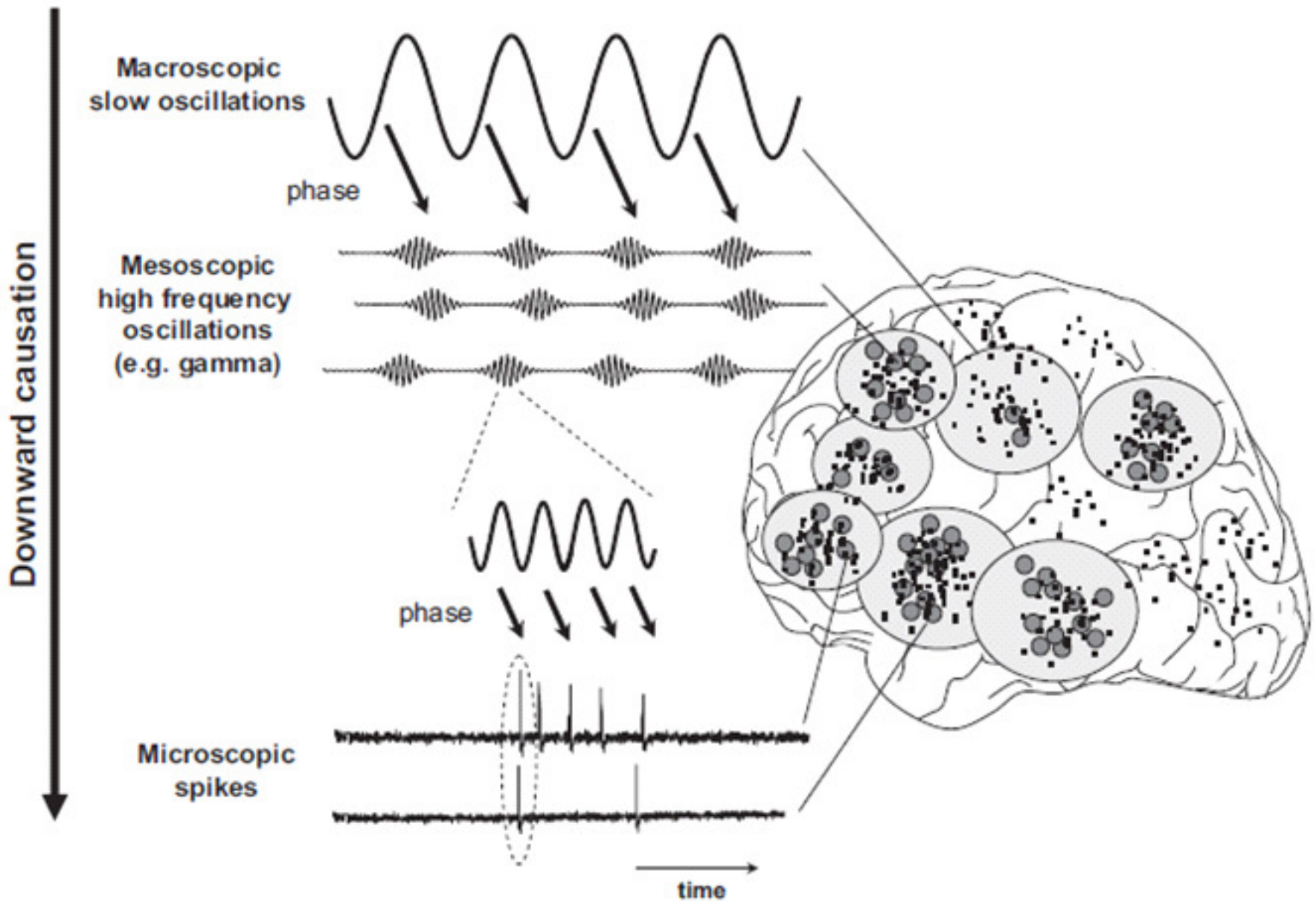

# Loreta Default Brain Network

## Frontal

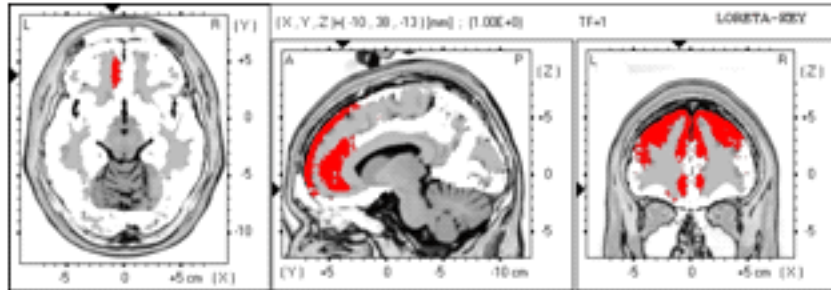

## Anterior Cingulate

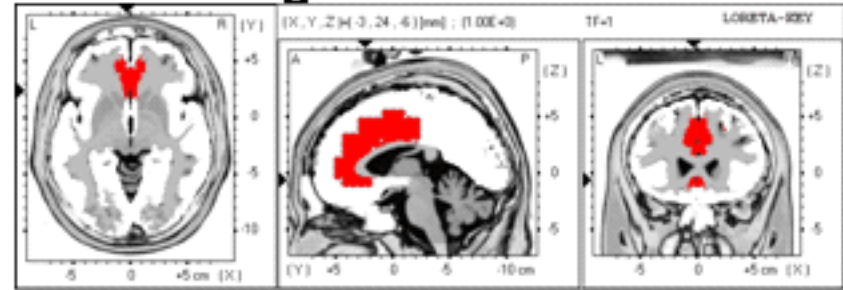

## Temporal

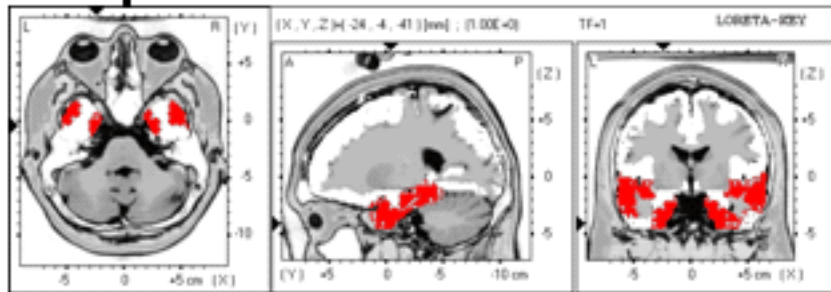

## Hippocampus

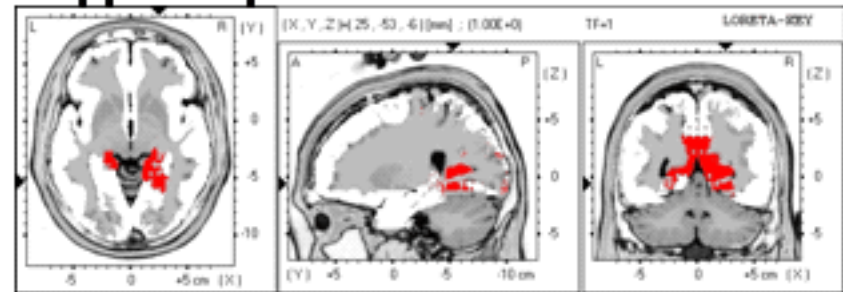

## Posterior Cingulate

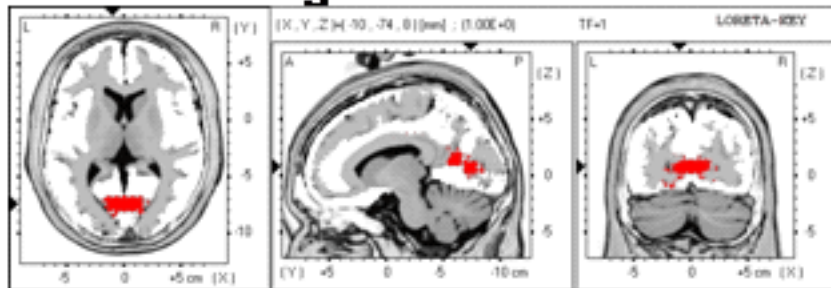

## Parietal

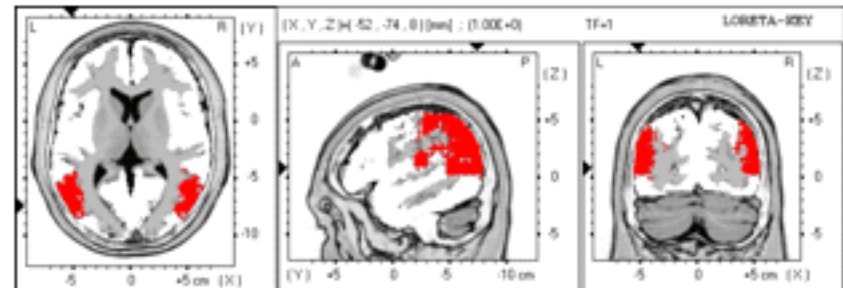

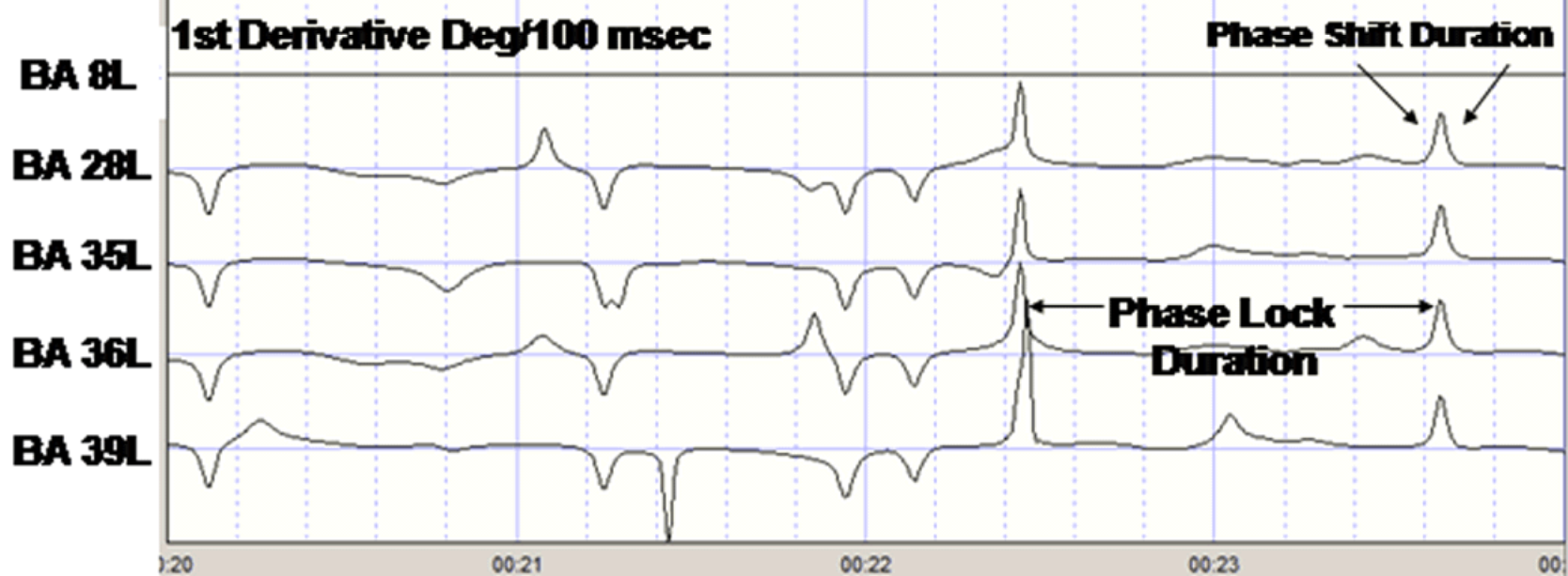
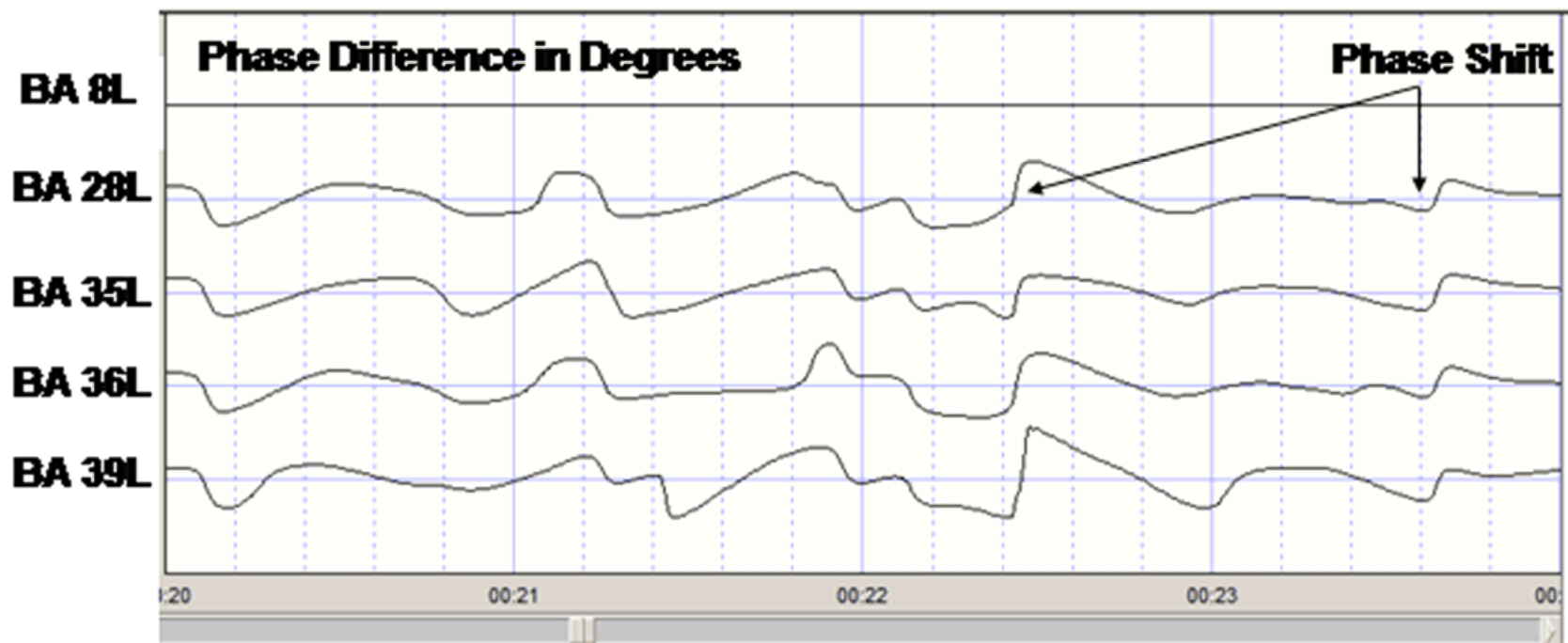

# Phase Reset Shift Duration LORETA Default Brain Brodmann Area Pairs

## X-Shift

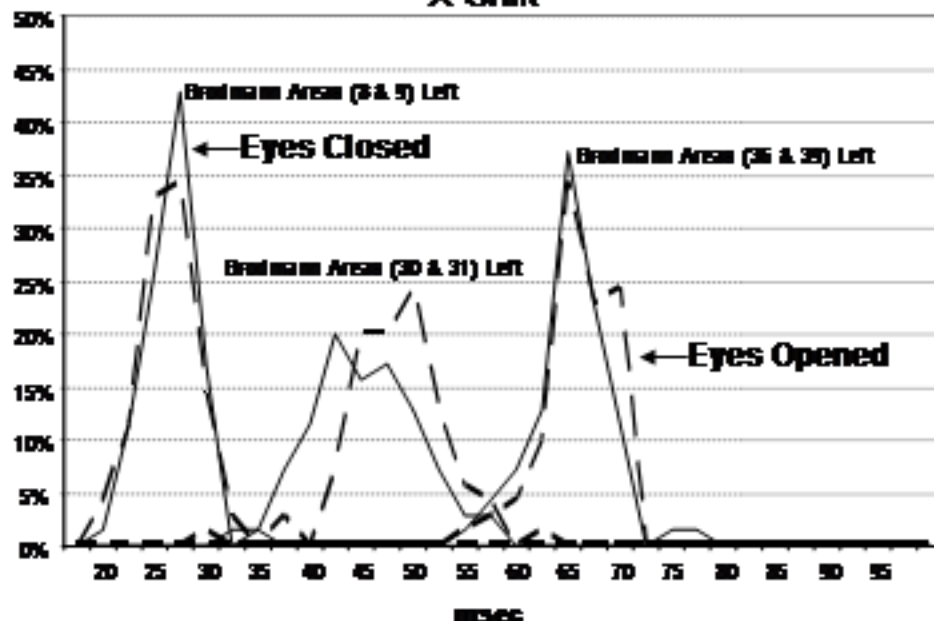

## Y-Shift

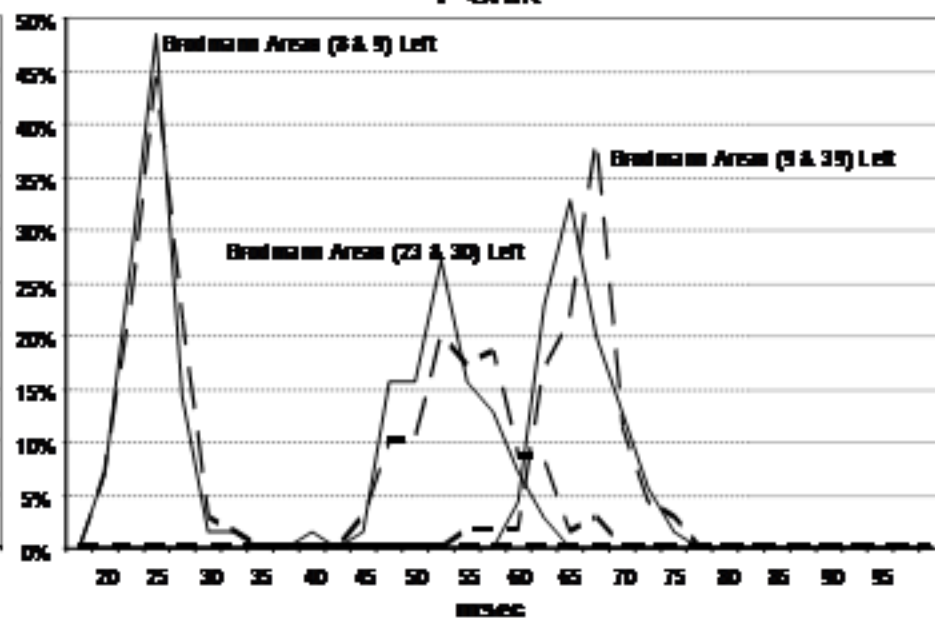

## Z-Shift

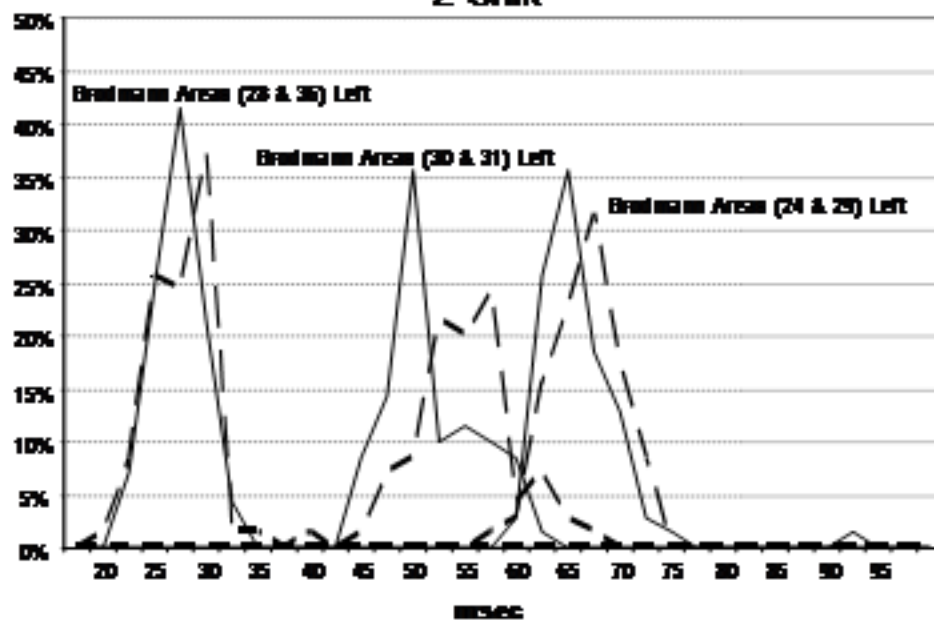

## R-Shift

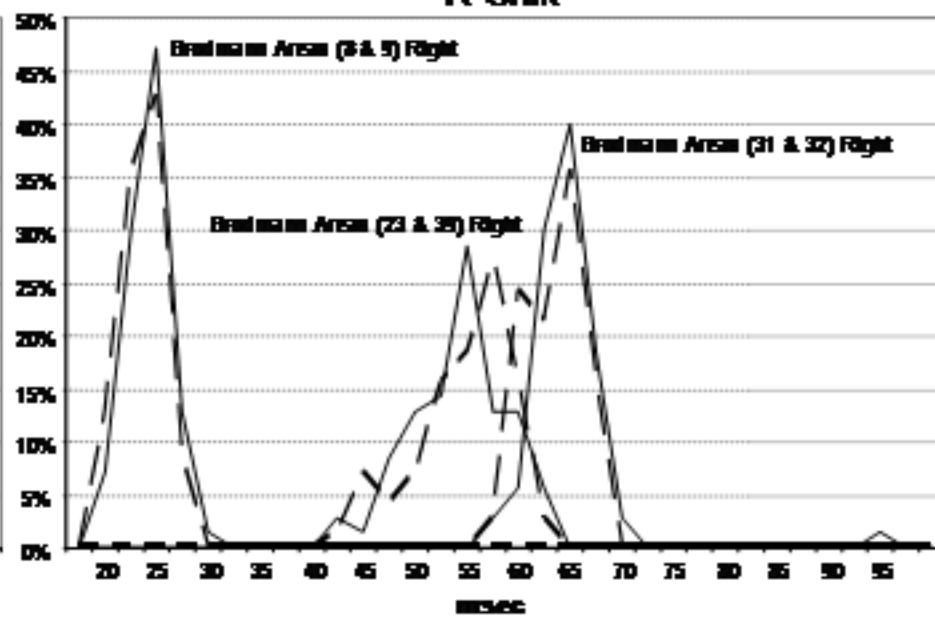

# Phase Reset Lock Duration LORETA Default Brain Brodmann Area Pairs

## X-Lock

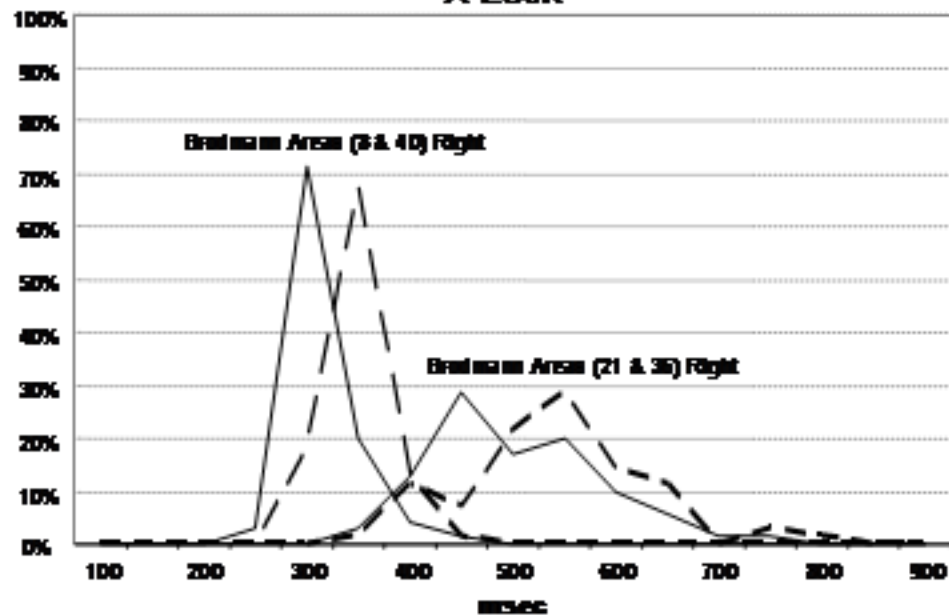

## Y-Lock

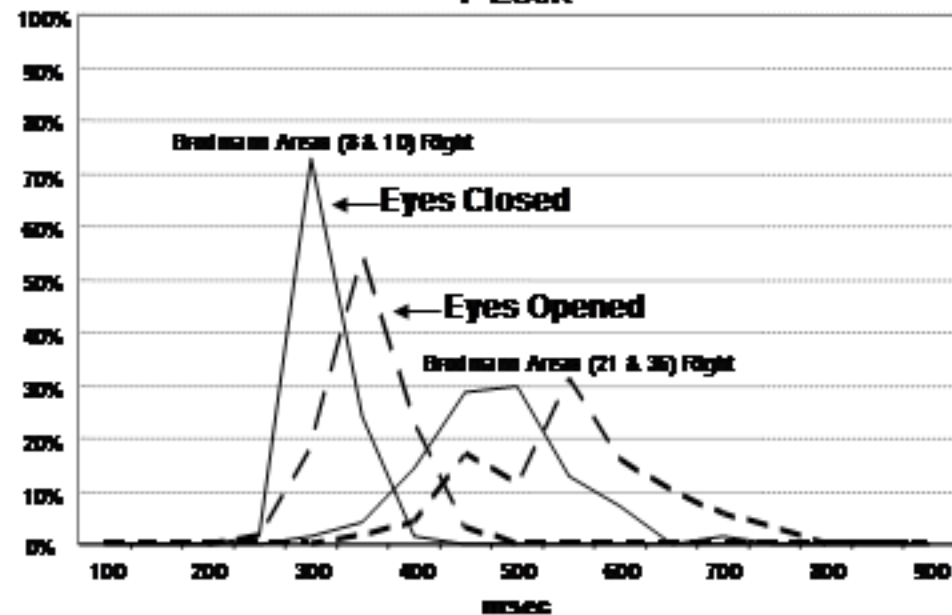

## Z-Lock

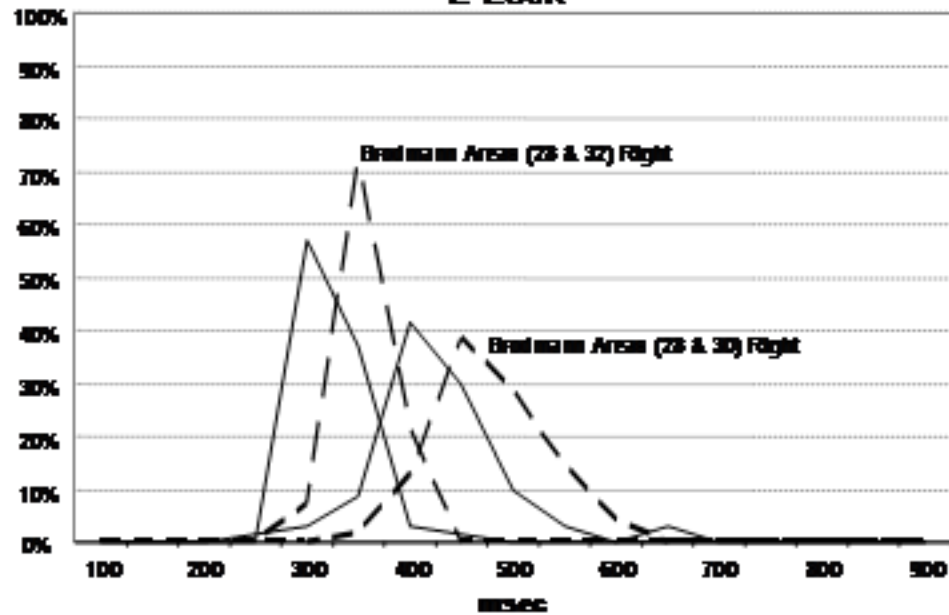

## R-Lock

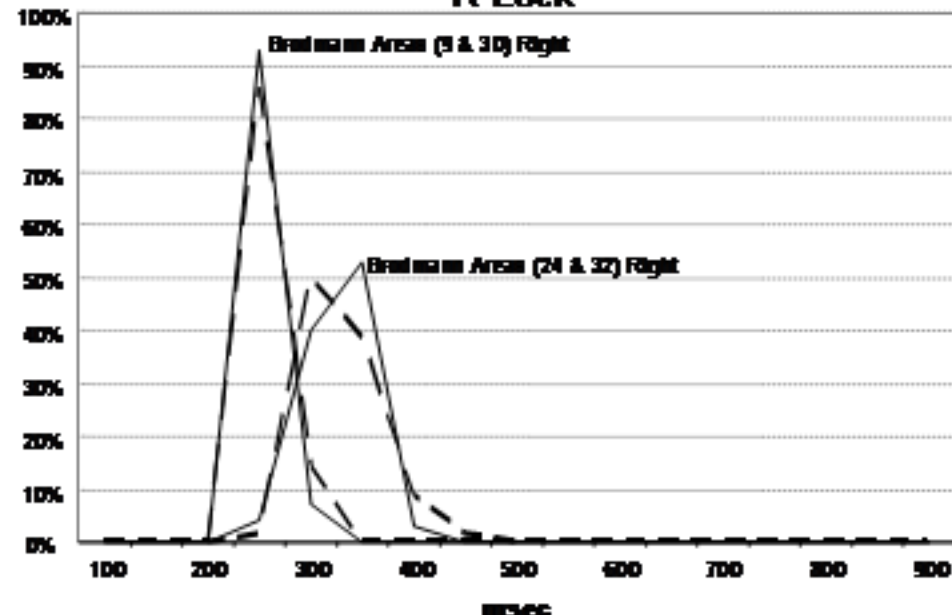

## Relations Between Phase Reset Shift & Lock Means and the Euclidean Distance Between Voxels

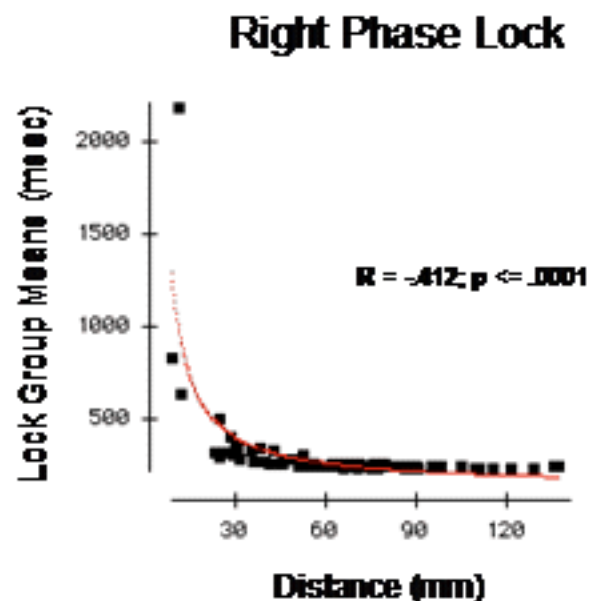
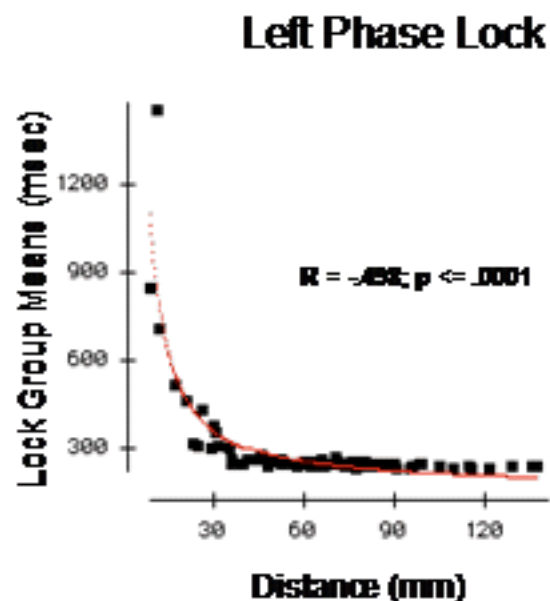
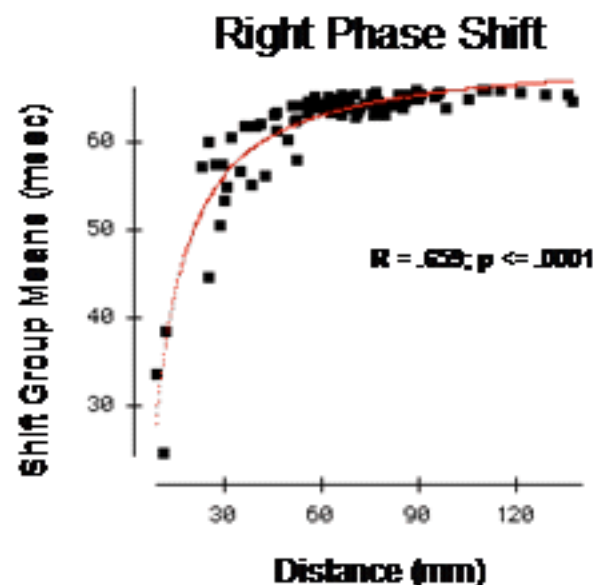
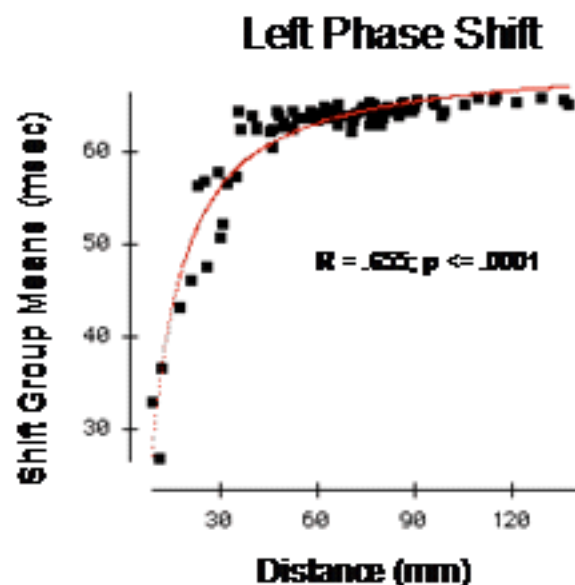

## Correlations of Default Brain Phase Difference with Euclidean Distance Distances

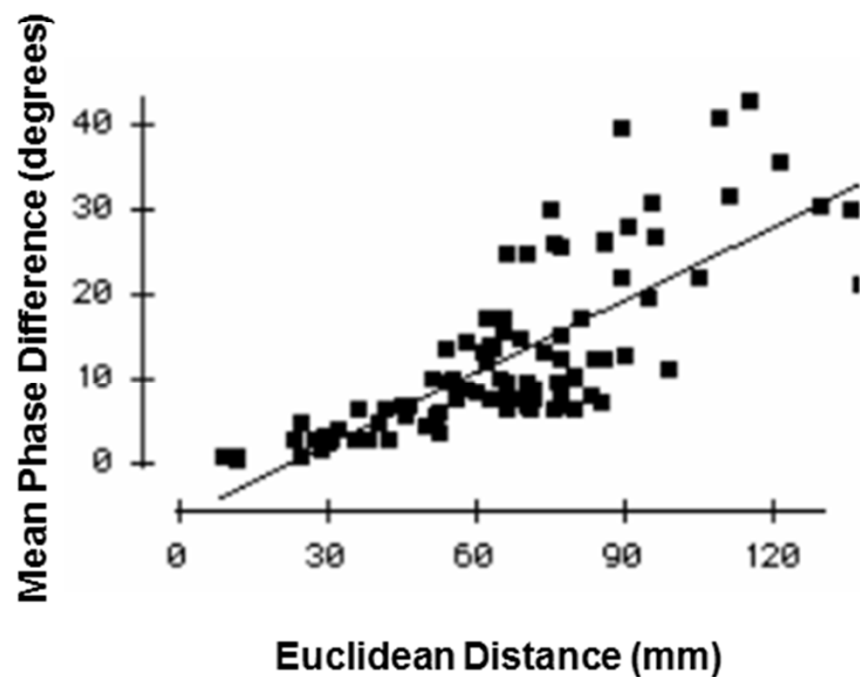
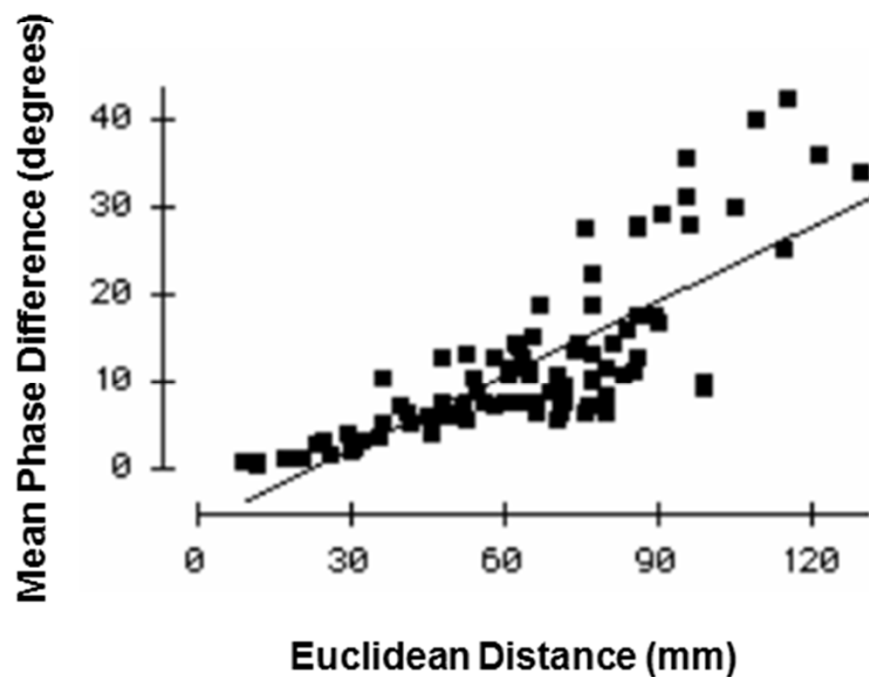

### Non-Linear Exponential Brodmann Area Distances: Shift vs Lock

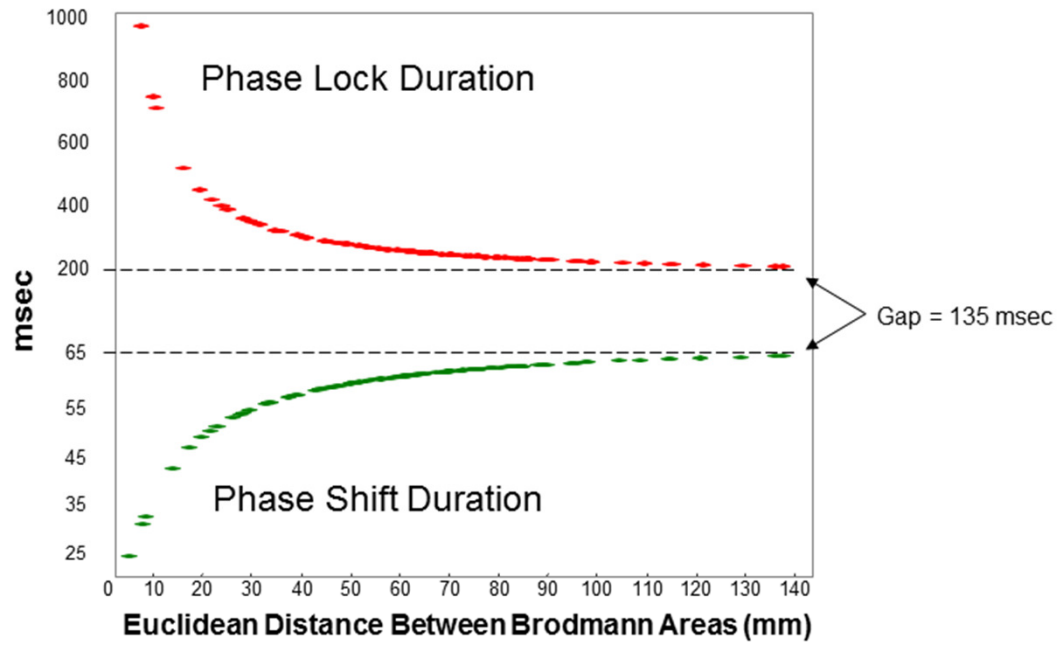

Published as a chapter in “Introduction to QEEG and Neurofeedback: Advanced Theory and Applications” Thomas Budzinsky, H. Budzinski, J. Evans and A. Abarbanel editors, Academic Press, San Diego, Calif, 2008.

# **HISTORY OF THE SCIENTIFIC STANDARDS OF QEEG NORMATIVE DATABASES**

**Thatcher, R.W. <sup>1,2</sup> and Lubar, J.F. <sup>3</sup>**

**Department of Neurology, University of South Florida College of Medicine, Tampa, Fl.<sup>1</sup> and EEG and NeuroImaging Laboratory, Applied Neuroscience, Inc., St. Petersburg, Fl<sup>2</sup>, Brain Research and Neuropsychology Lab, University of Tennessee, Knoxville, TN<sup>3</sup>.**

NORMATIVE DATABASE N = 727 Subjects as of 8/24/2011

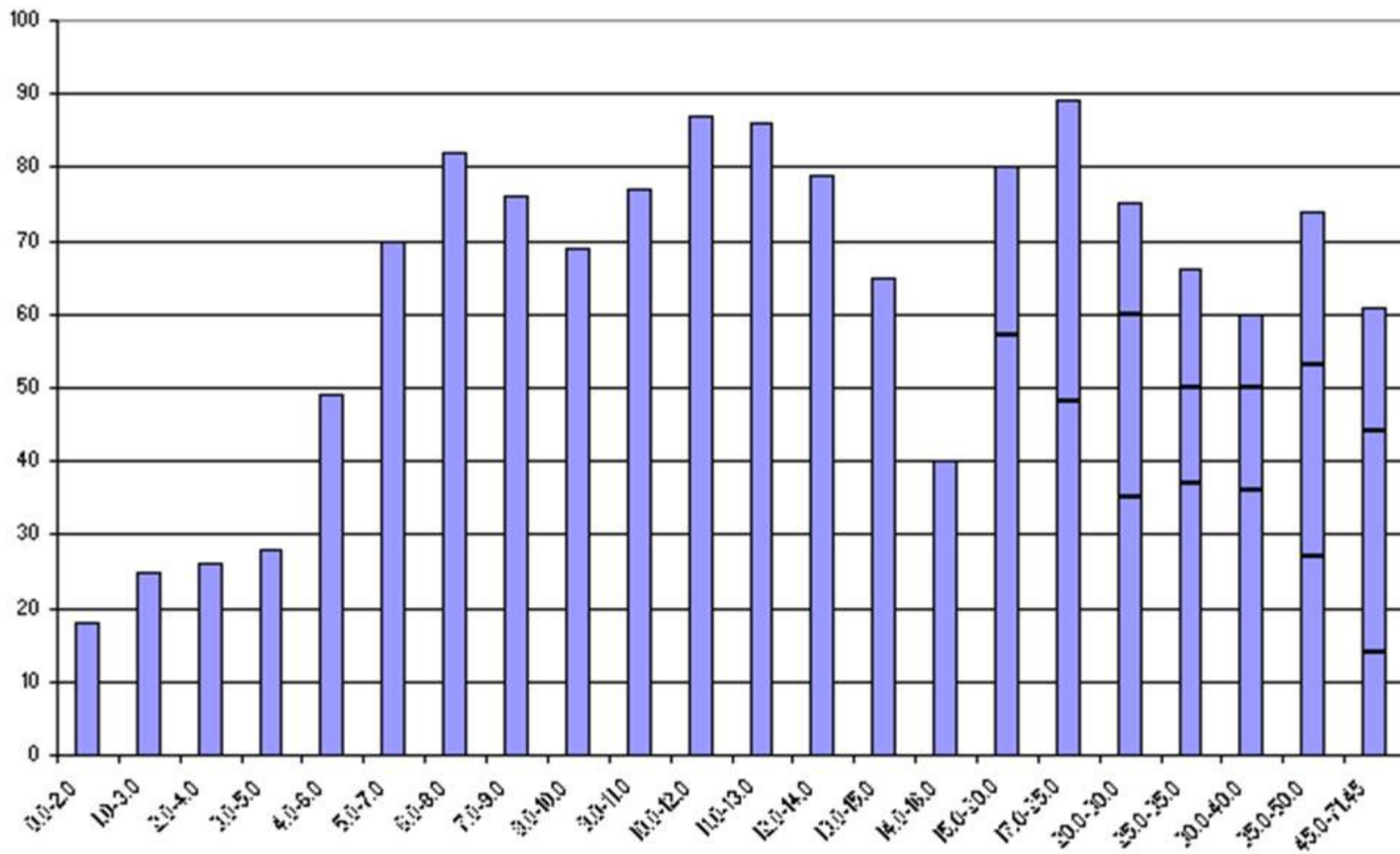

# Normative Database Validation Steps

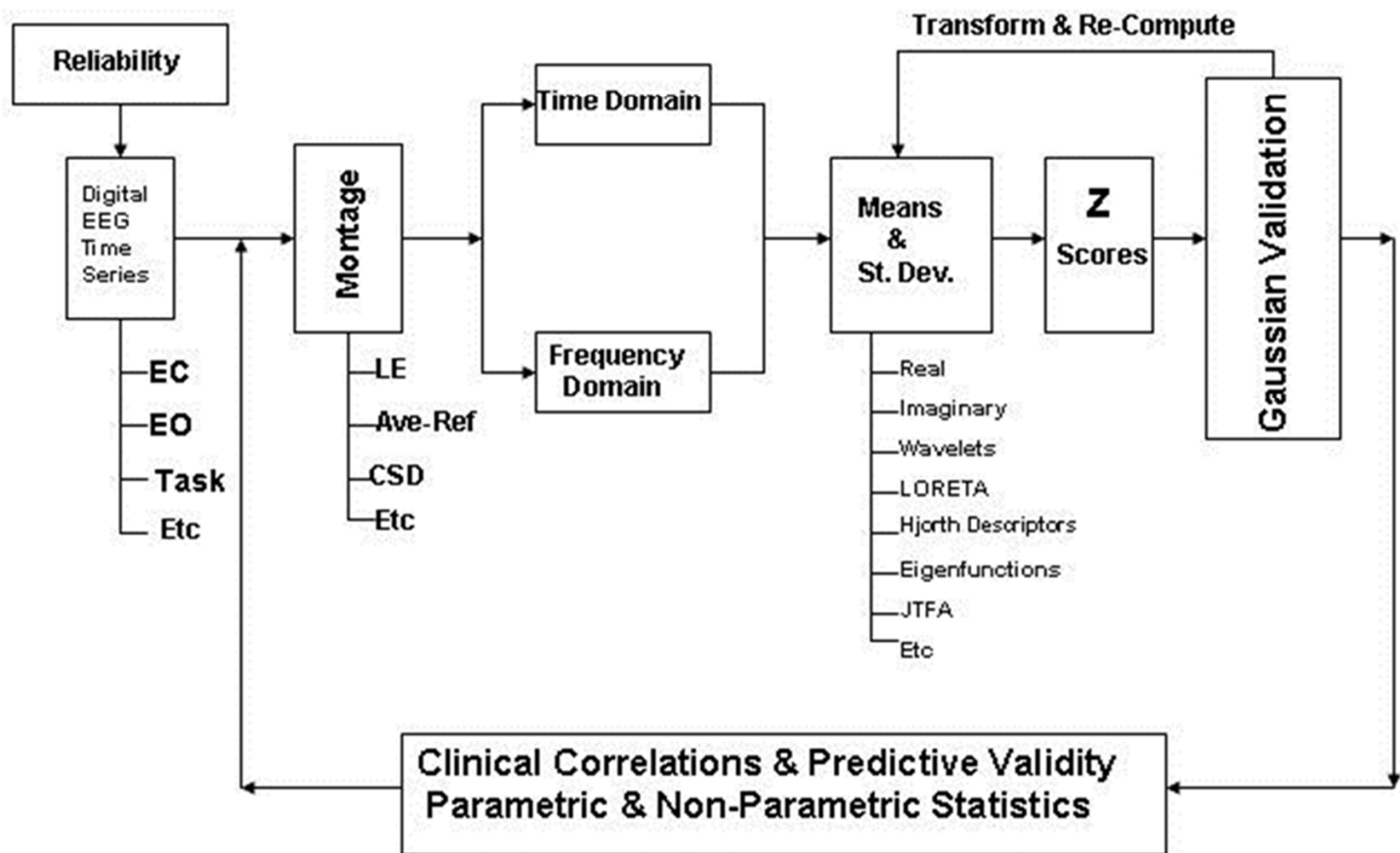

## Sensitivity Based on Deviation from Gaussian

Cross-Validation Accuracy N = 625 Subjects

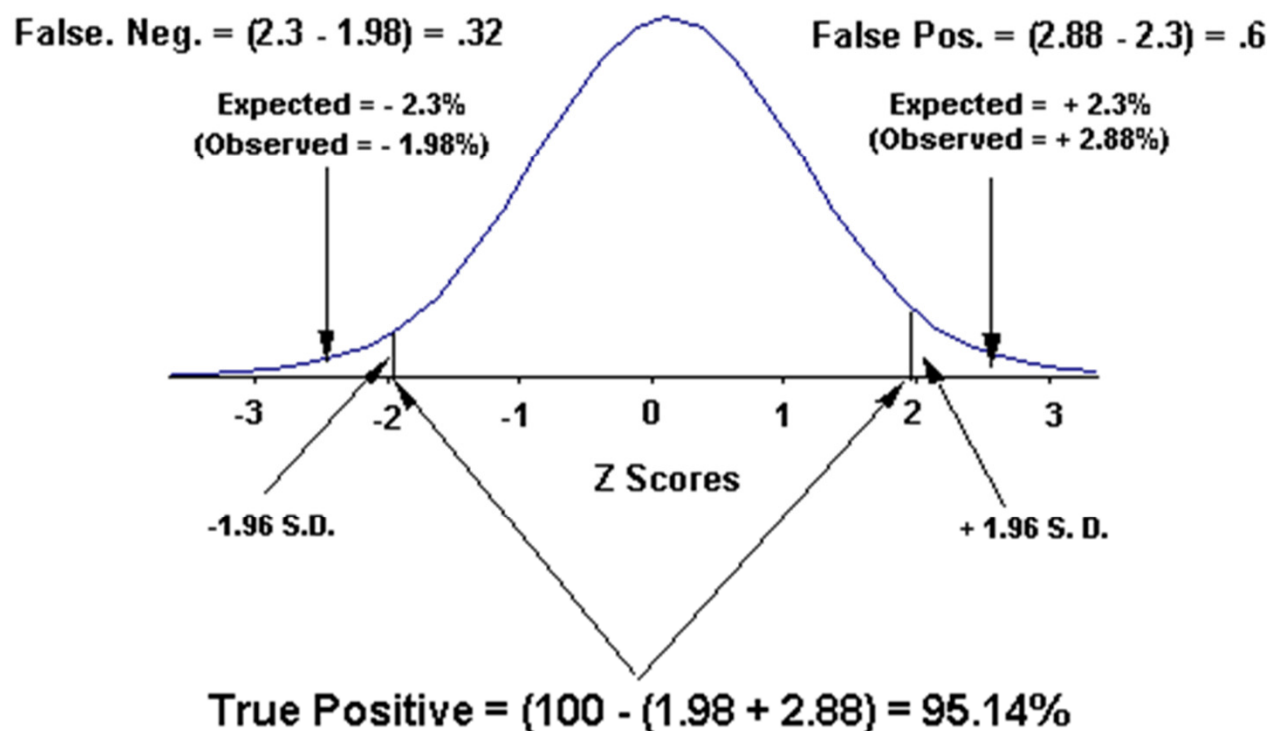

$$\text{Sensitivity} = \frac{\text{TP}}{\text{TP} + (\text{FP} + \text{FN})} = \frac{95.14}{95.14 + 1.0} = 98.96\%$$

$$\text{Specificity} = \frac{\text{TN}}{\text{TN} + (\text{FP} + \text{FN})} = \text{Undefined}$$

# Cross-Validation Birth to 82 Year EEG Normative Database

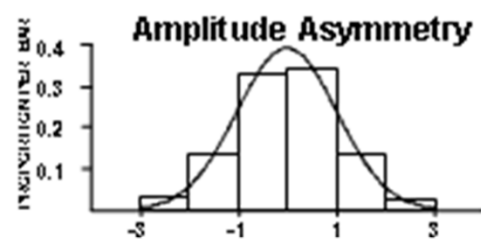

DELTA

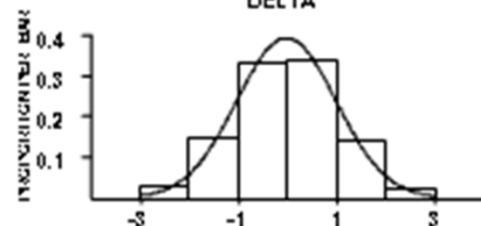

THETA



ALPHA

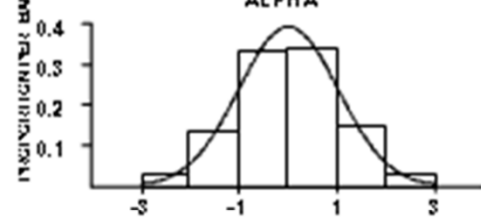

BETA

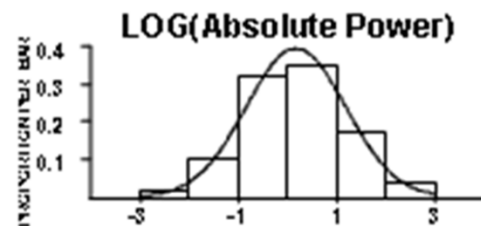

All Frequency I

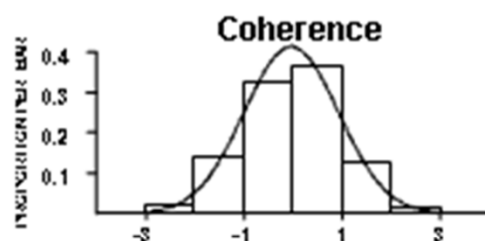

DELTA

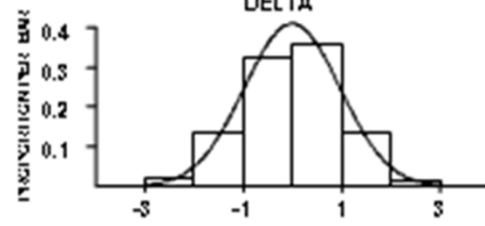

THETA

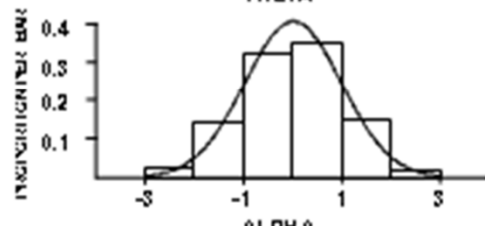

ALPHA

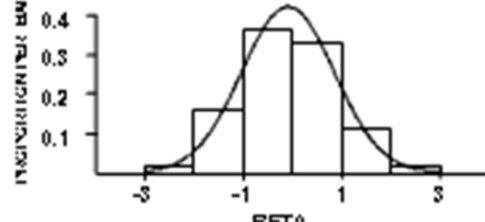

BETA

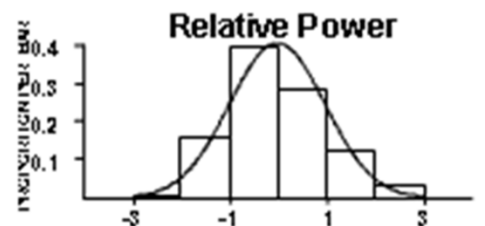

All Frequency I

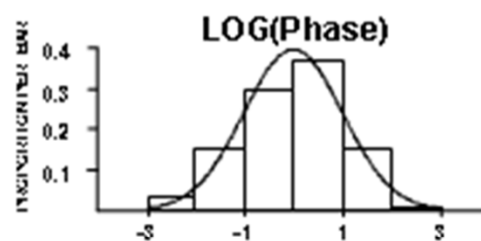

DELTA

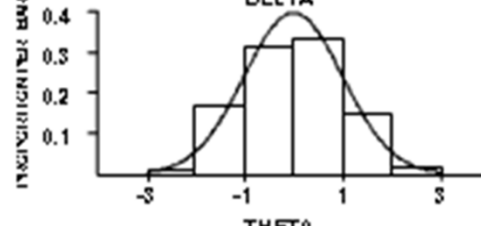

THETA

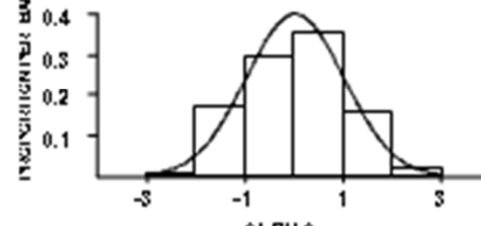

ALPHA

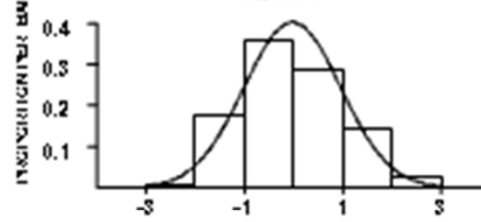

BETA

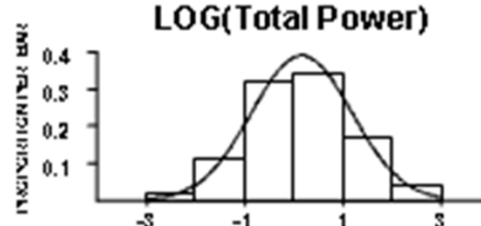

ALL

## FFT Normative Database Sensitivities

2 STDEVs	CALC SENSITIVITY: $FP=TP/(TP+FP)$ or $FN=TP/(TP+FN)$			
AGES	(+/- 2 SD)	(>= 2 SD)	(<= -2 SD)	
0-5.99	0.95448265	0.9771774	0.97730526	<b>+/- 2 Std. Dev.</b>
6-9.99	0.95440363	0.9772031	0.97720054	
10-12.99	0.9543997	0.97724346	0.97715624	
13-15.99	0.95440512	0.97723601	0.97716911	
16-ADULT	0.9543945	0.97718143	0.97721307	
ALL	0.95442375	0.97720714	0.97721661	
3 STDEVs	CALC SENSITIVITY: $FP=TP/(TP+FP)$ or $FN=TP/(TP+FN)$			
AGES	(+/- 3 SD)	(>= 3 SD)	(<= -3 SD)	
0-5.99	0.99743898	0.99871123	0.99872774	<b>+/- 3 Std. Dev.</b>
6-9.99	0.99744112	0.99871611	0.99872501	
10-12.99	0.99744688	0.99873171	0.99871518	
13-15.99	0.99743186	0.99871951	0.99871234	
16-ADULT	0.99743835	0.99870216	0.99873619	
ALL	0.99744002	0.99871716	0.99872286	

# Normative Database Amplifier Matching – Microvolt Sine Waves 0 to 40 Hz

## Equilibration Ratios to Match Frequency Responses

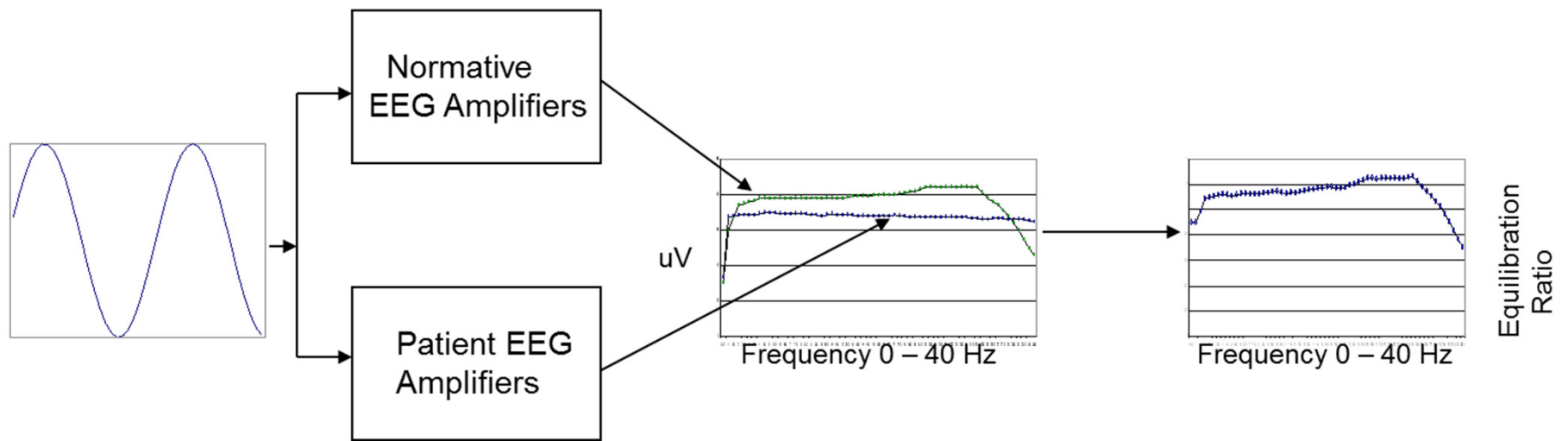

# Cross-Validation of NeuroGuide vs NxLink

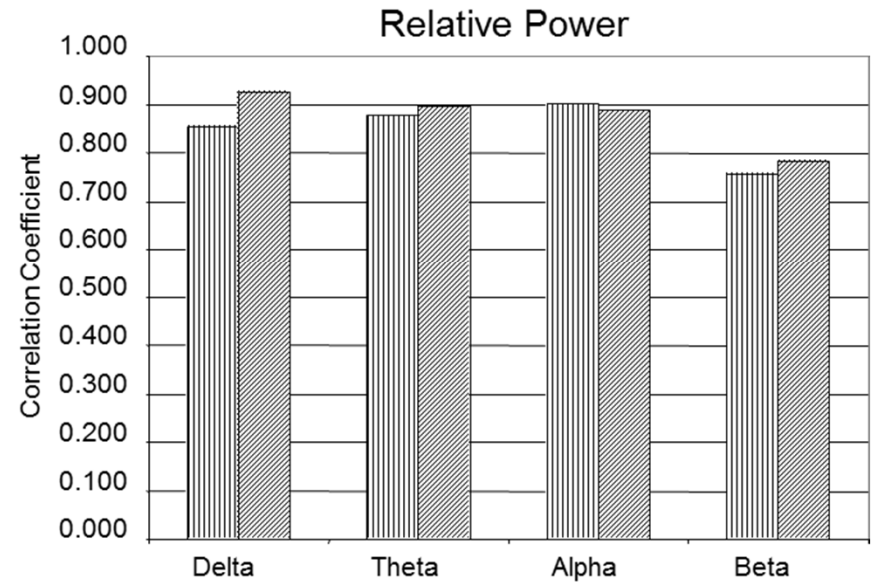
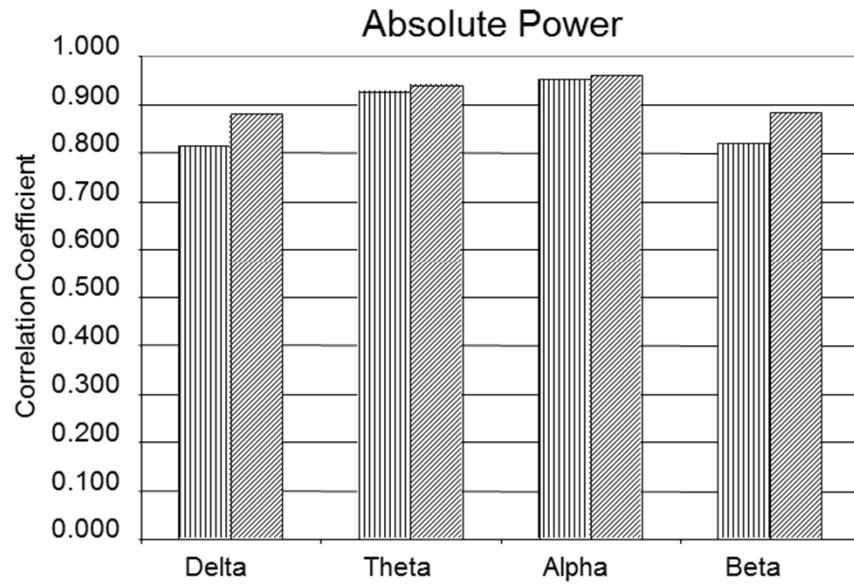

Anterior Posterior

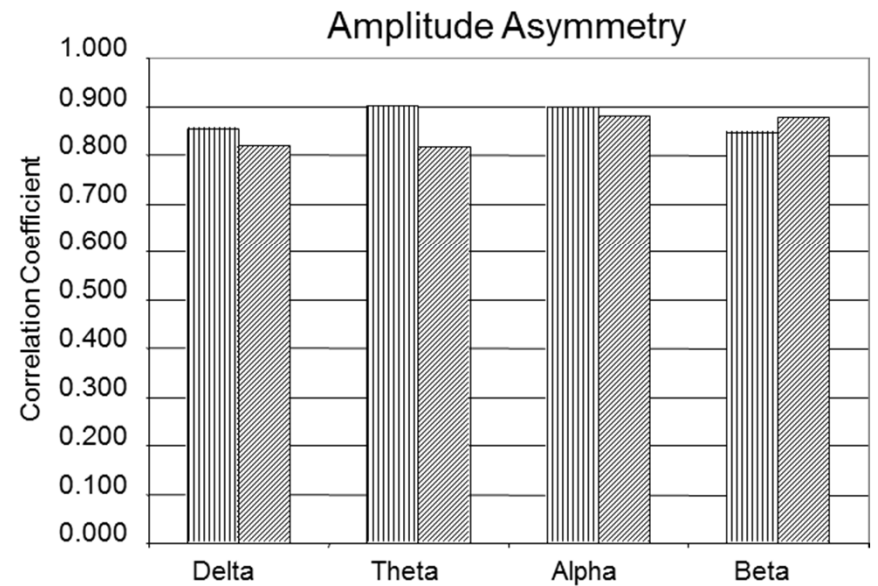
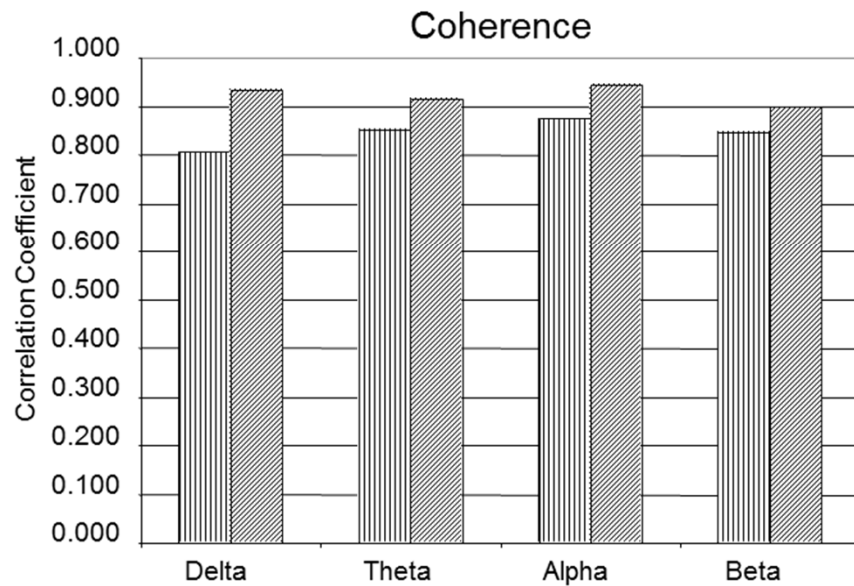

### Multiple Regressions of QEEG with FULL IQ

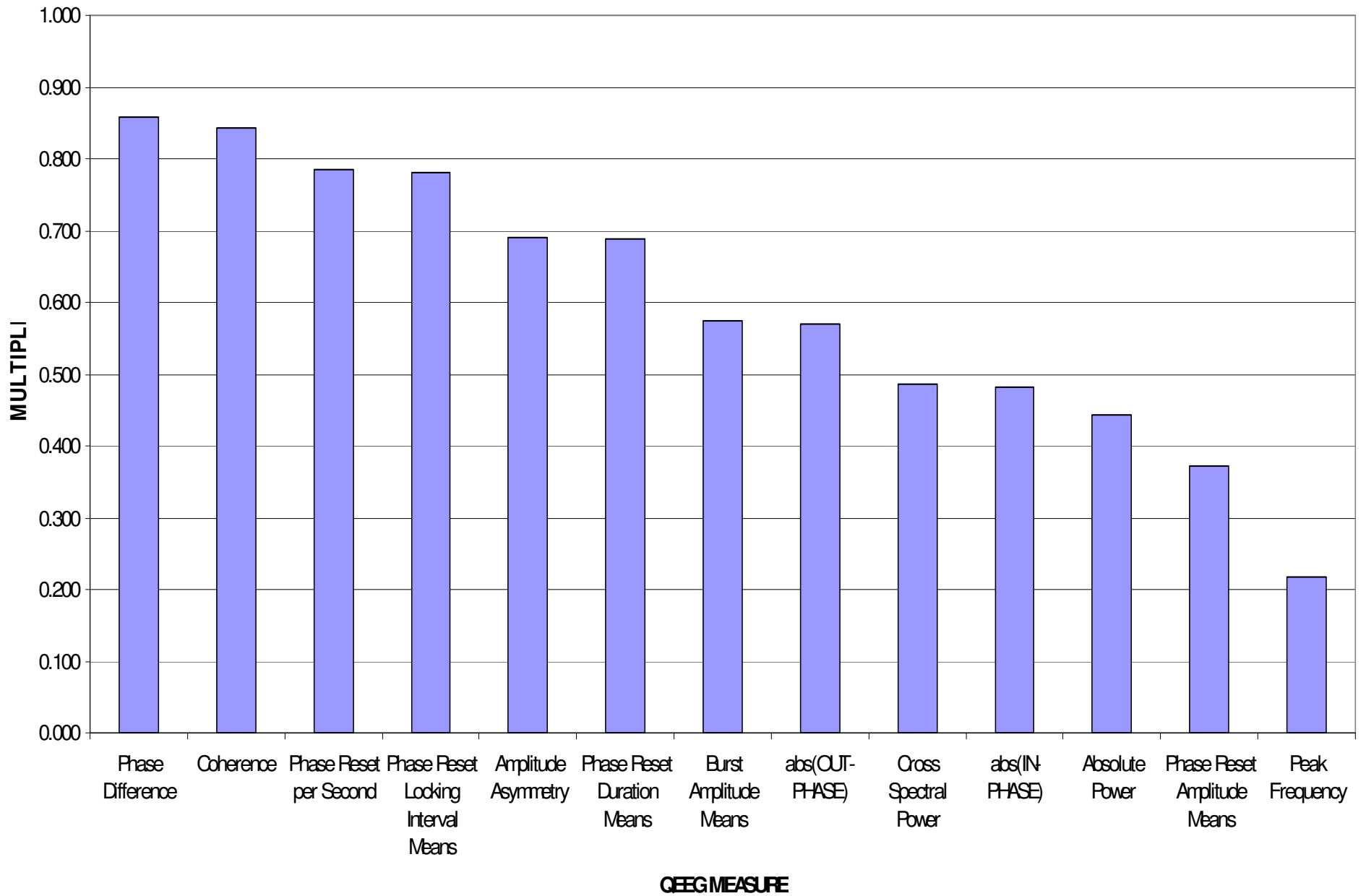

Table IV  
List of “Gold Standards” by which to judge  
QEEG Normative databases

	Standards	Yes	No
1	Peer reviewed publications		
2	Amplifier Matching		
3	Artifact Rejection		
4	Test Re-Test Reliability		
5	Inclusion/exclusion criteria		
6	Adequate Sample size per age group		
7	Approximation to a Gaussian		
8	Cross-Validation		
9	Clinical Correlation		
10	FDA Registered		

## **Some Relevant Items and Questions**

**Loops in the Brain and Why Homeostasis and Equilibrium are Critical for Brain Function**

**The EEG is Produced Exclusively by Summated Synaptic Potentials**

**How does EEG Biofeedback Change the EEG?**

**How does EEG Biofeedback Change Synaptic Potentials?**

**What are the Mechanisms of Modification of Synapses by Operant Conditioning of EEG at the Molecular Level? (nu. Accumbens & reinforcement)**

**Eric Kandel “In Search of Memory” Norton & Co., 2006 – Nobel Prize 2000**

**Gyorgy Buzsaki “Rhythms of the Brain”, Oxford Univ. Press, 2006**

## Essentials of Operant Conditioning

- 1- There must be a 'real' & 'valid' neural event to be reinforced
- 2- The 'Reinforcement' must be distinct and clear
- 3- The interval of time between the spontaneous 'emitted event' & the 'reinforcement' can not be too short, approx.  $< 250$  msec? or too long approx.  $> 20$  sec
- 4- The Schedule of Reinforcement is Important with two General Types "Continuous" vs 'Partial' Reinforcement - Continuous is good at the beginning but not as resistant to extinction as is Partial Reinforcement

# A General Theory of EEG Operant Conditioning and Z Score Biofeedback

## Definitions

- 1- Duration of Spontaneous EEG Event (E) = Neural State Interval (I)
- 2- Contiguity Window (C) = Time period preceding and following a E
- 3- Reward Signal (S) = Feedback signal time locked to E
- 4- Reward Strength (R) = Value of the reward if N successes occur in an interval of time, e.g., toys, candy, cookies, money, etc.

## Category

## Measurement

Category	Measurement
Duration of Spontaneous EEG Event (E)	Neural State Interval (I) (msec)
Contiguity Window (C)	Time preceding/following E (msec – sec)
Reward Signal (S)	Feedback signal time locked to E (msec)
Reward Strength (R)	Ordinal or Nominal measure

# Contiguity Window

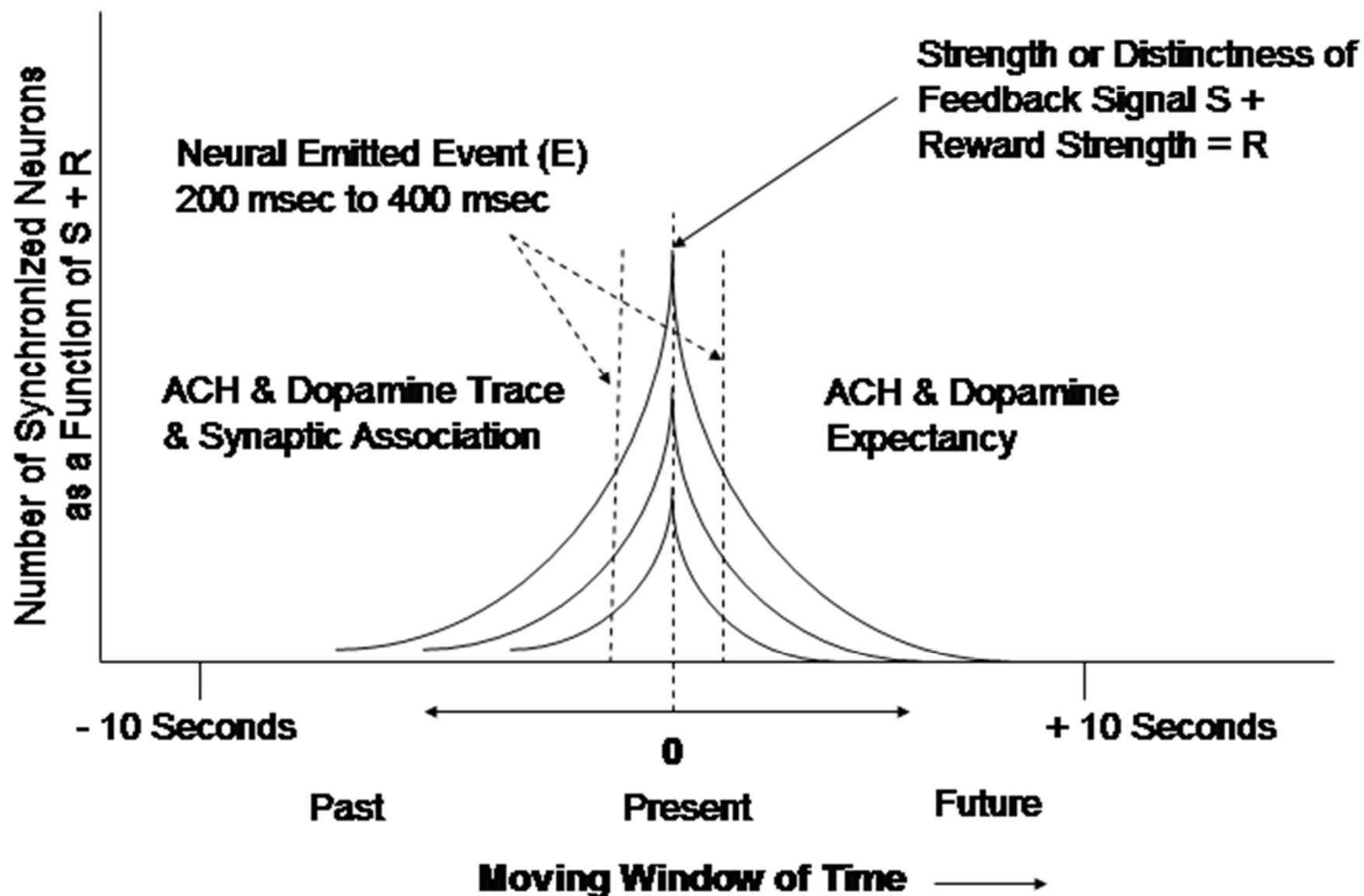

# EEG Neurofeedback

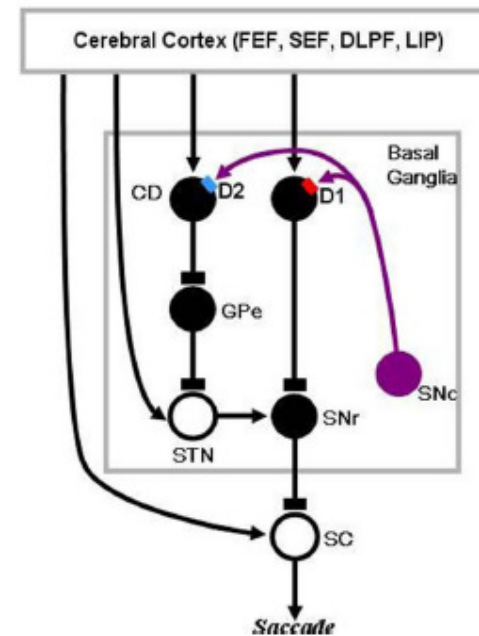
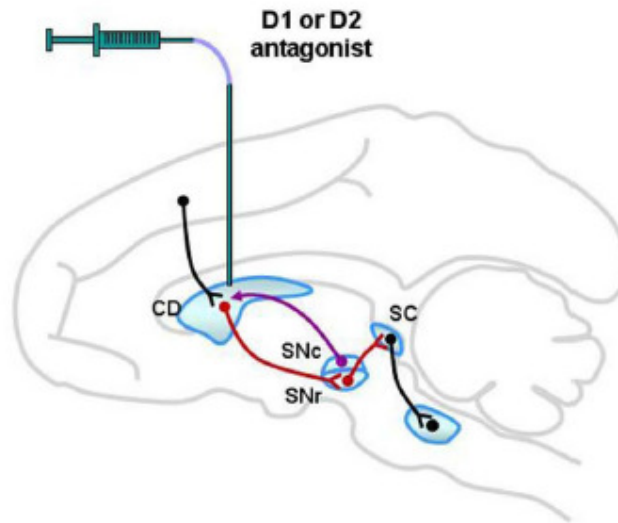
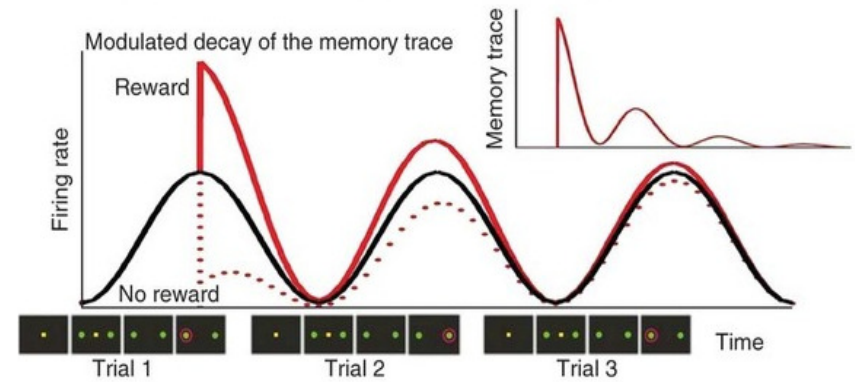
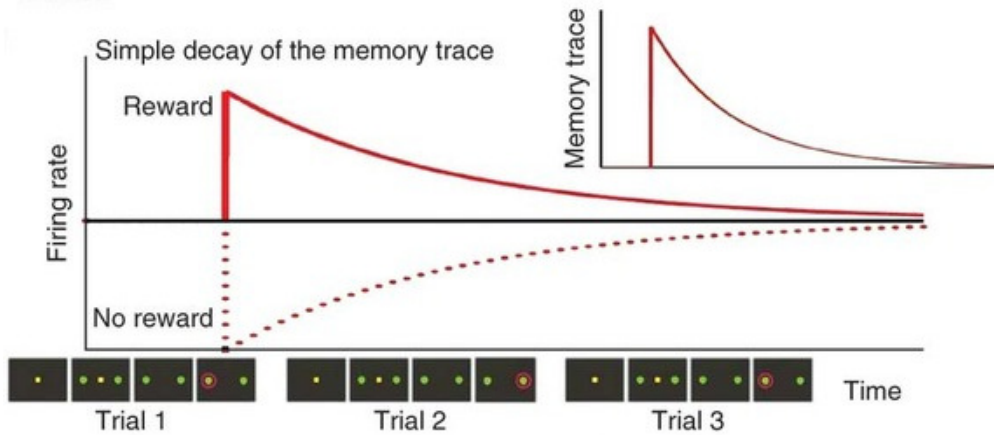

# Difference Between Standard Neurofeedback vs Z Score Neurofeedback

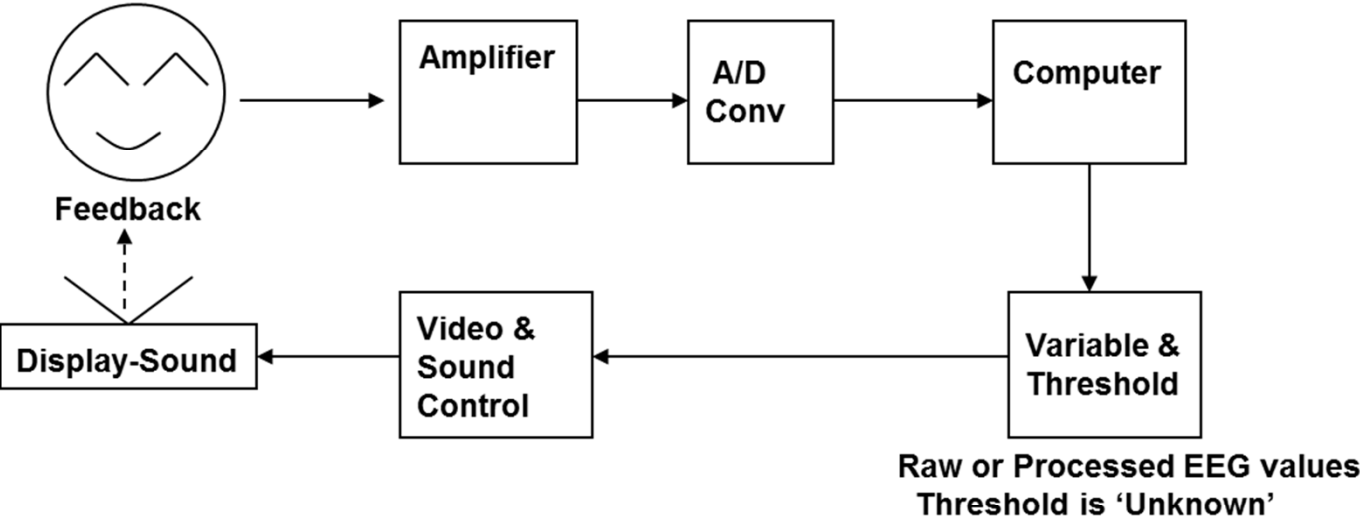

## Standard EEG Neurofeedback

- 1- Apples & Oranges
- 2- Arbitrary Threshold
- 3- No reference to Guide NF

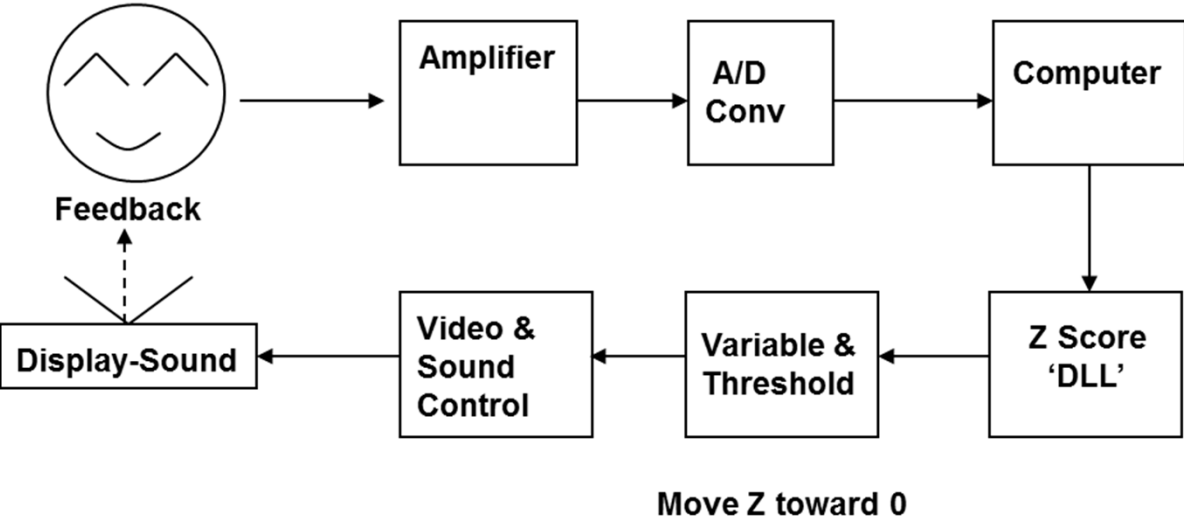

## Real-Time or "Live" Z Score Neurofeedback

- 1- Metric, i.e., a 'Z' Score
- 2- Threshold toward '0'
- 3- Instantaneous Comparison to a normative database

# Complex Demodulation

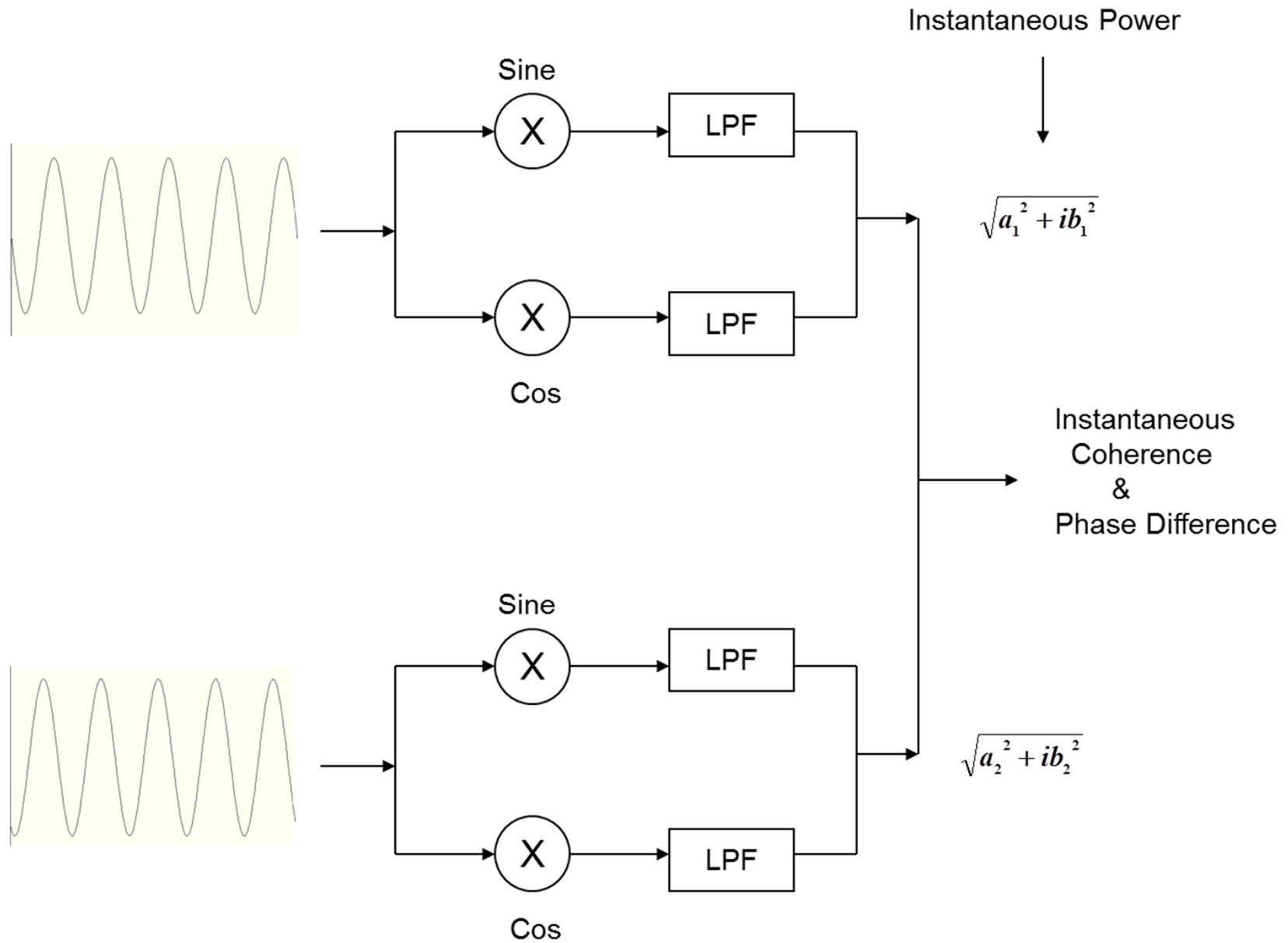

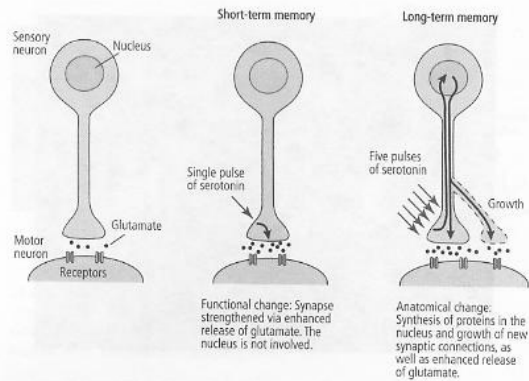

18-4 Changes underlying short- and long-term memory in a single sensory and motor neuron.

days and led to the growth of new synaptic connections, an anatomical change that did involve the synthesis of new protein (figure 18-4). This showed us that we could initiate new synaptic growth in the sensory neuron in tissue culture, but we still needed to find out what proteins are important for long-term memory.

My career in neurobiology now intersected with one of the great intellectual adventures of modern biology: the unraveling of the molecular machinery for regulating genes, the coded hereditary information at the heart of every life form on earth.

THIS ADVENTURE BEGAN IN 1961 WHEN FRANÇOIS JACOB AND Jacques Monod of the Institut Pasteur in Paris published a paper entitled "Genetic Regulatory Mechanisms in the Synthesis of Protein." Using bacteria as a model system, they made the remarkable discovery that genes can be regulated—that is, they can be switched on and off like a water faucet.

Jacob and Monod showed that in a complex genome is present all of the chromosomes necessary to produce a protein in every cell of the body. It proved to be that every cell in a brain is a brain cell. Some genes are turned on and some are repressed. The different subpopulations of neurons enables

Genes are involved in the regulation of the organization of the organ. The brain requires energy, and energy is essential for the brain to respond only at certain times. This set of genes is turned on at night: What is the function of these genes, with or without patterns of activity?

What sort of genes turn on? Genes are switched on and off. Genes encode effective proteins that mediate specific functions. Called gene expression. Jacob and Monod showed that regulatory genes control the expression of other genes. A particular gene has a particular function as the promoter.

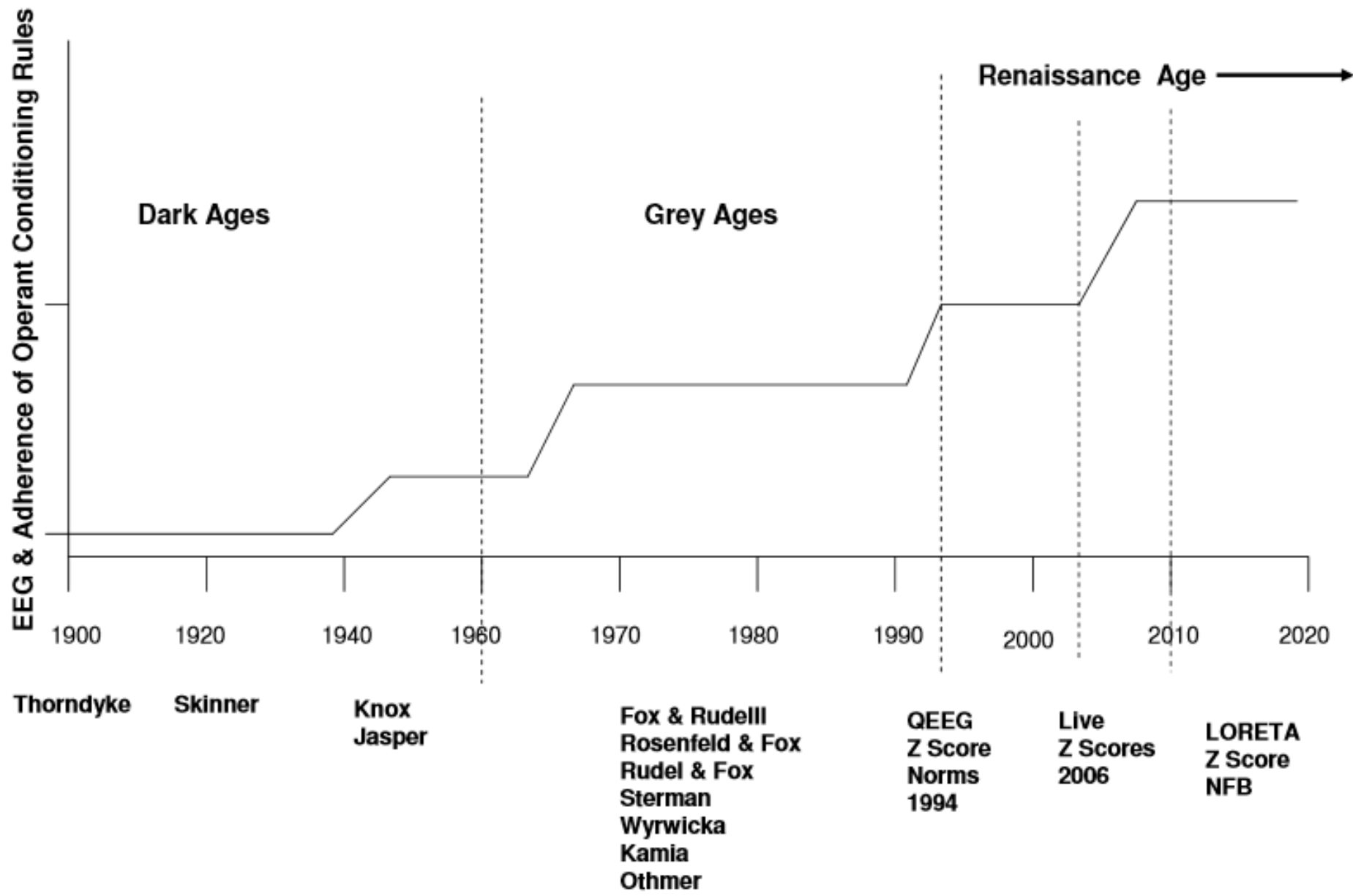

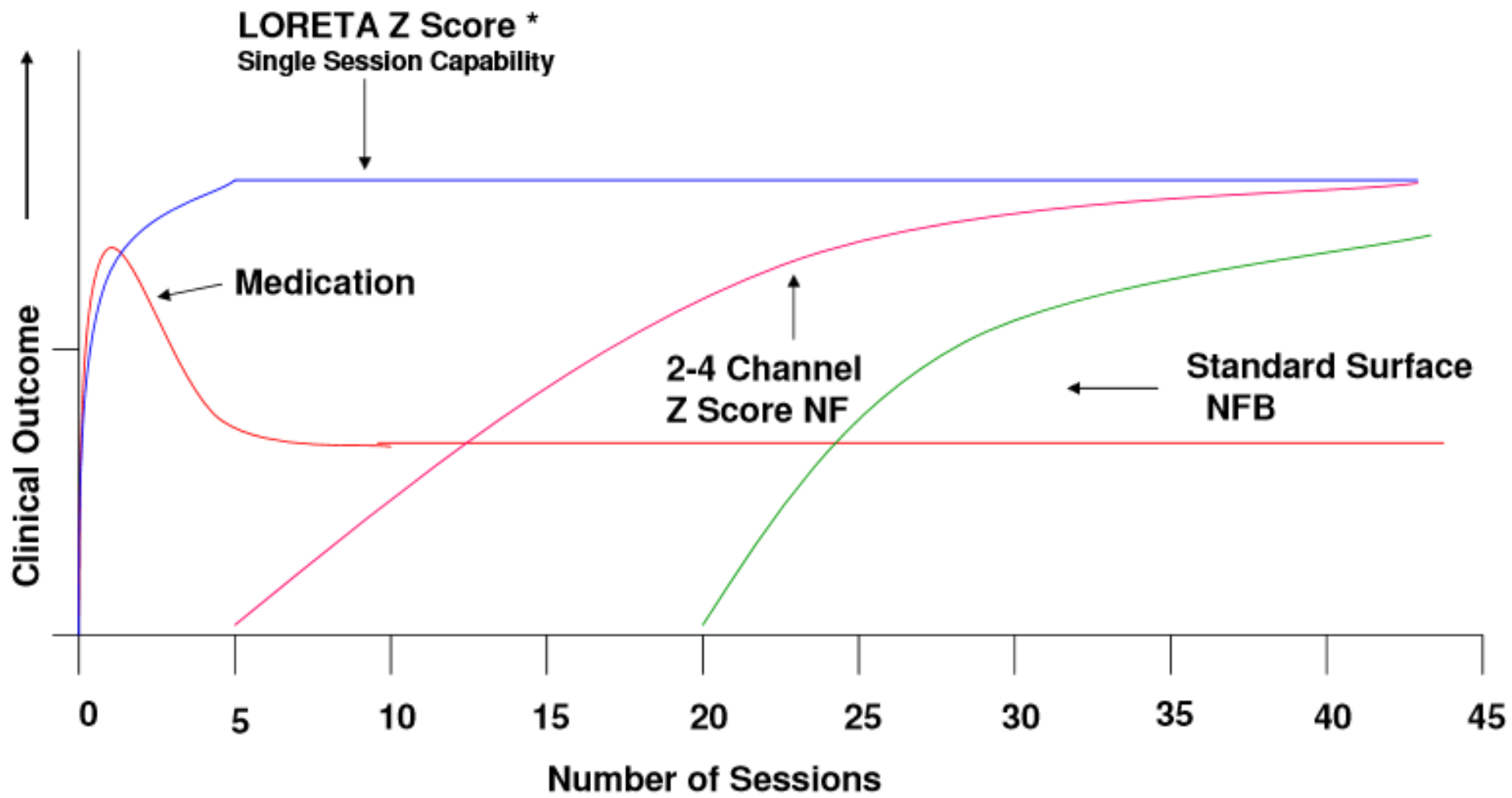

\* Combine with Neurofield in cases to reset or “unstick” the brain

**Seamless QEEG and Neurofeedback – approx. 50 – 60 minutes for a single Session in four Steps from Clinical Interview to QEEG to Neurotherapy**

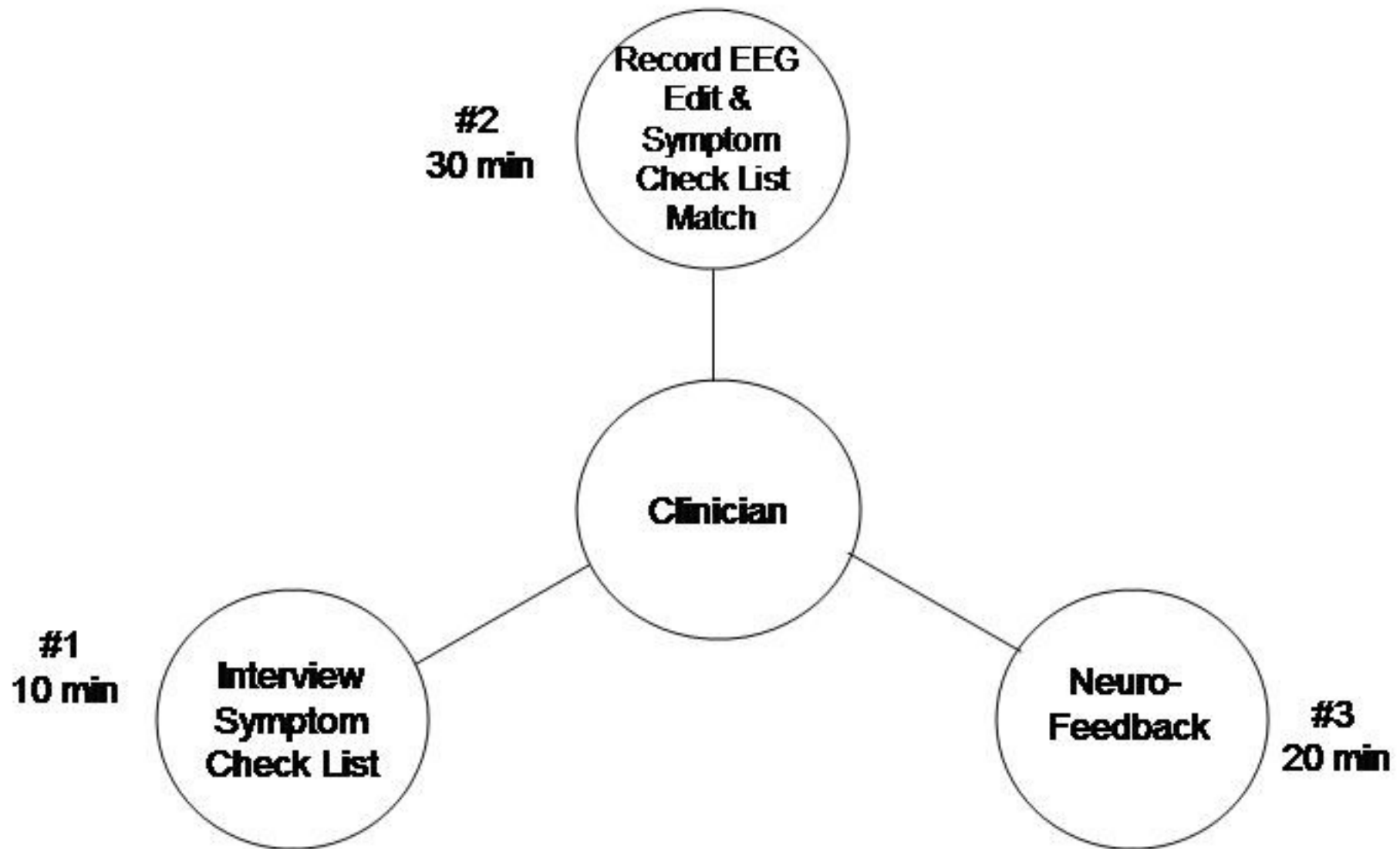

# Neuroimaging Neurofeedback – Fort Campbell

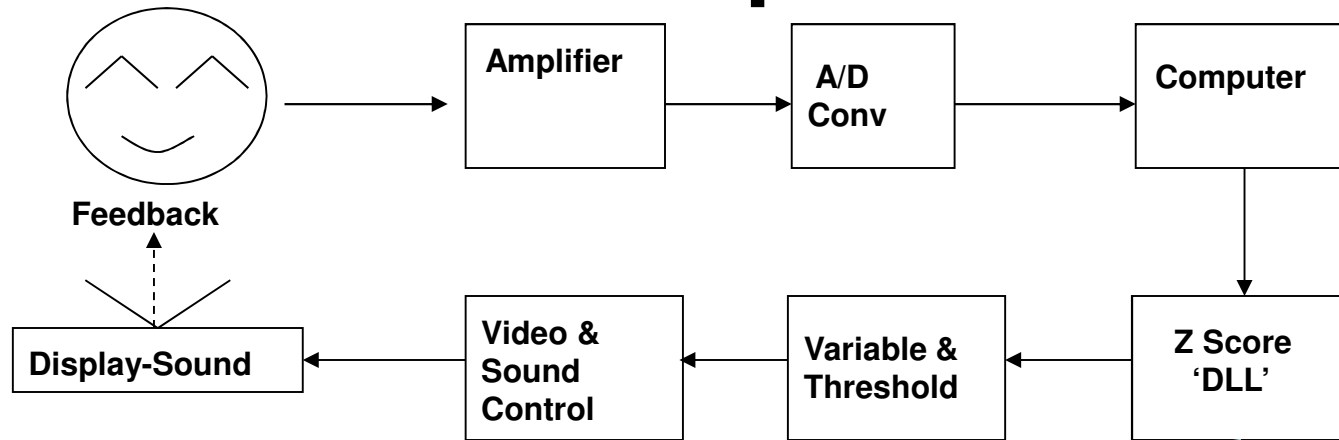

## Coherence & Phase

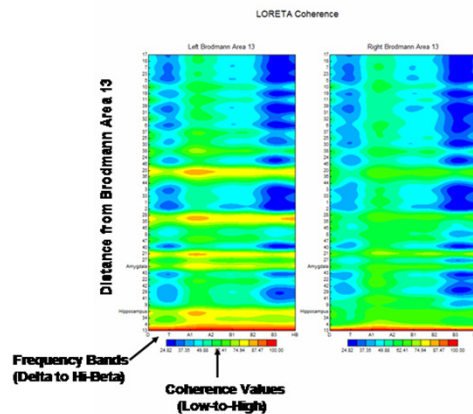

## Current Sources

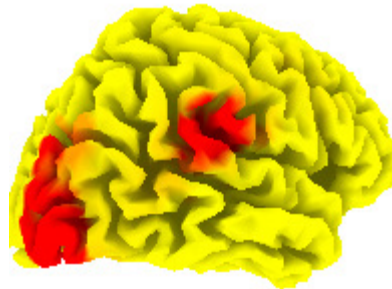

## Symptom Check List

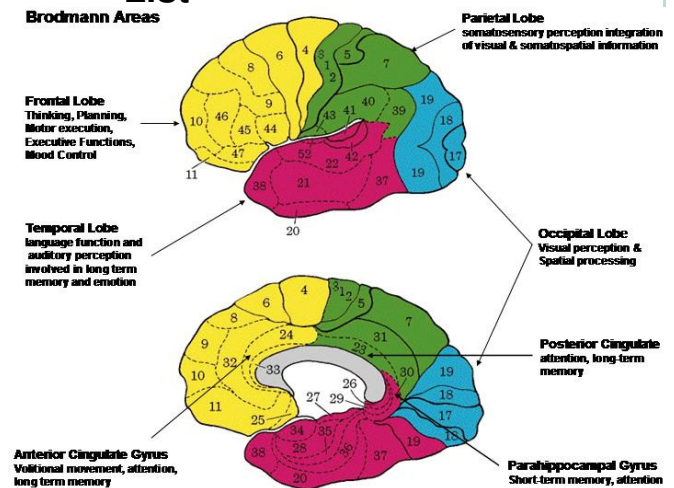

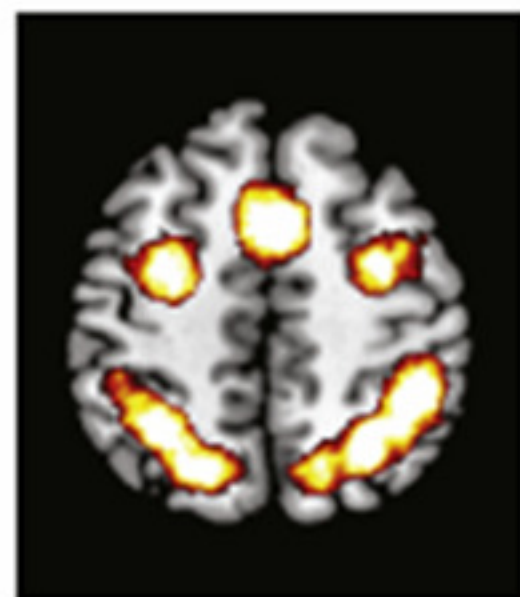
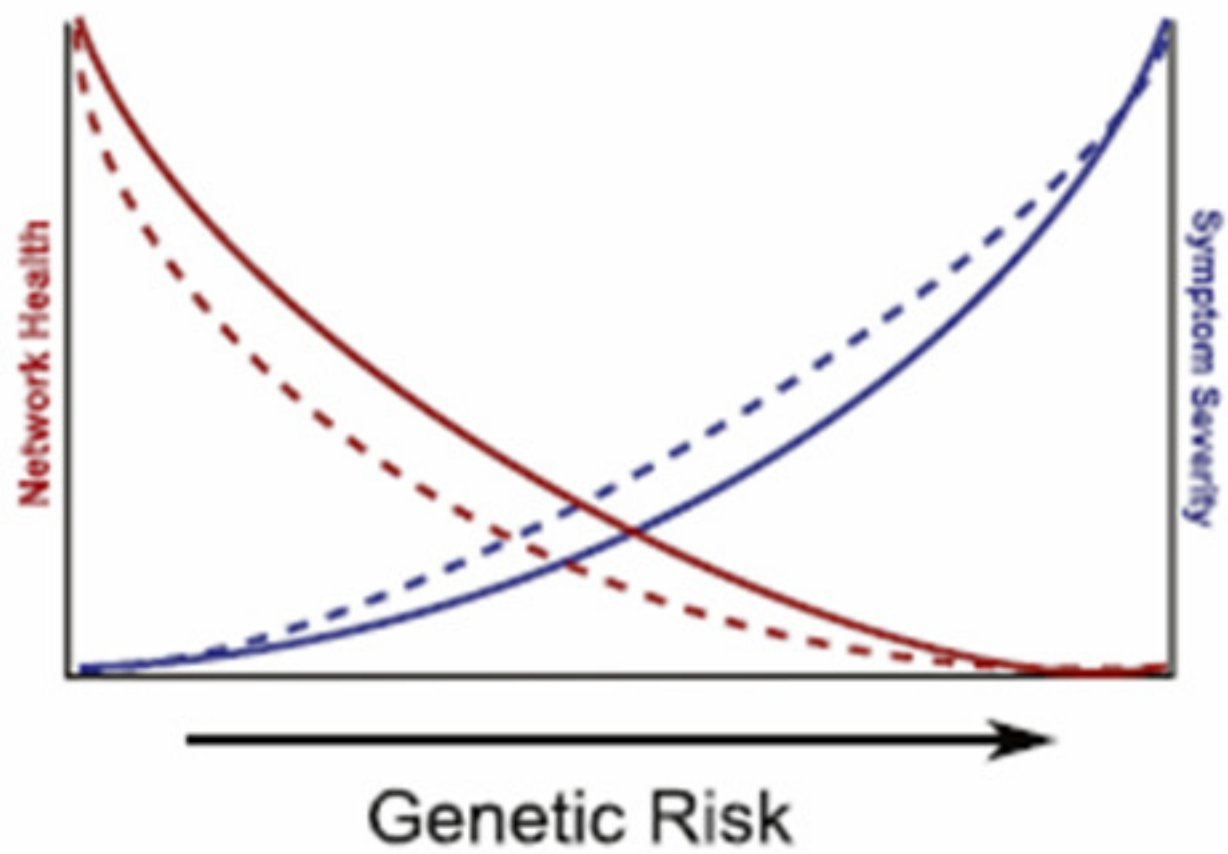

Frontoparietal  
Circuit

# Z Score Neurofeedback Panel

Select Frequency Bands & 1 to 19 Channels & Combinations of Channels for Cross-Spectra

Settings or Progress Chart Tabs

Select Power or Coherence, Phase Amp. Asym

Select Montage Laplacian, Ave. Ref & Linked Ears

Z Score Threshold Reward if Less Than Or greater than

Event Integration Interval (Variability)

Z Tunes is the Reward Default

Symptom Check List

Save, Load & Cancel

Sound on/off & Visual Displays & DVD/Flash

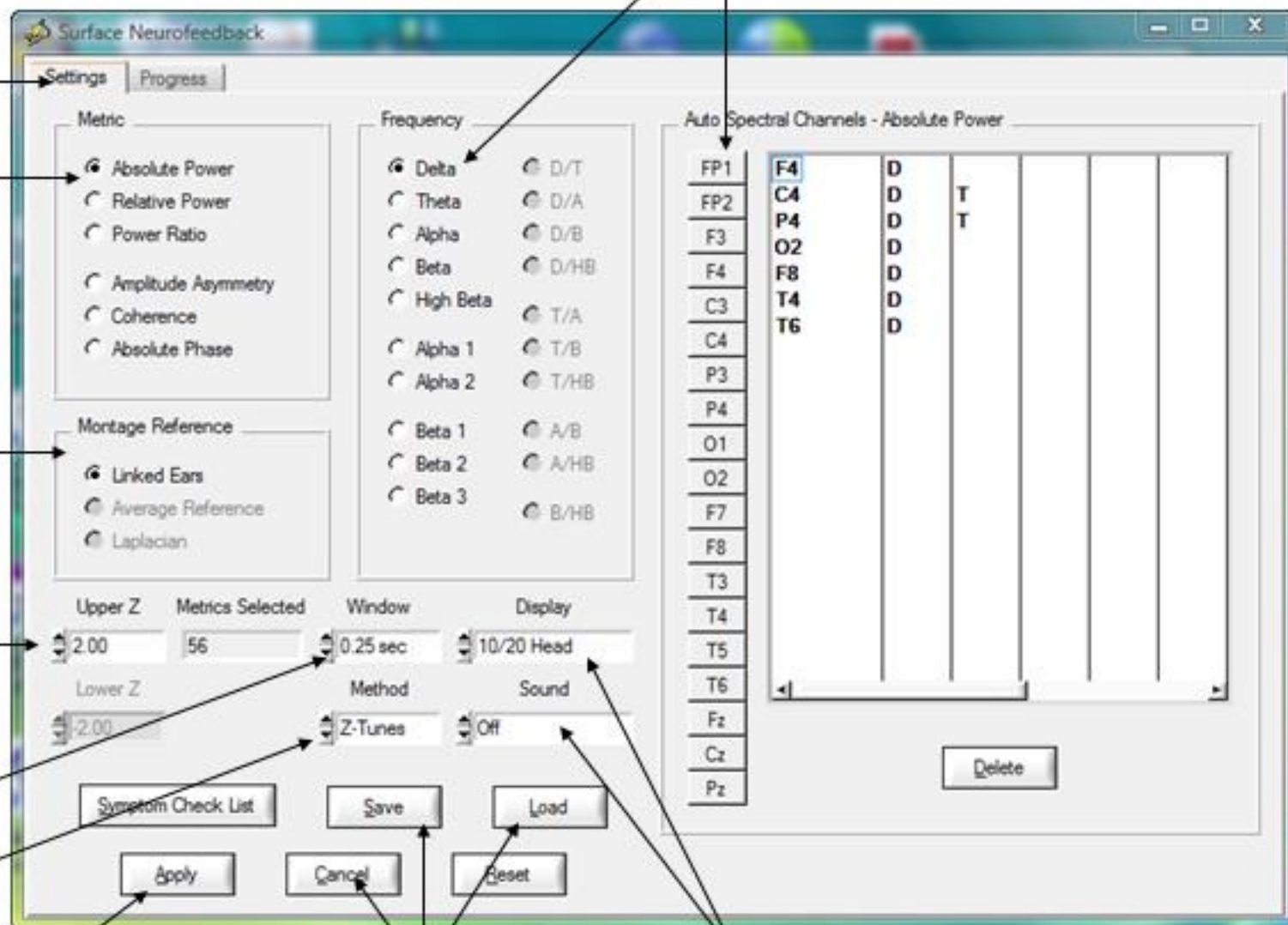

# Neuroimaging Neurofeedback Symptom Check List

Click Symptoms or Neuropsychological Diagnoses or Dod/VA List or Networks & Severity

List of Matching Brodmann Areas

List of Symptoms

Anatomical Hypotheses

The screenshot shows the 'Symptom Check List' application window. It features a tabbed interface with 'Symptoms', 'Neuropsychological', 'DoD/VA', 'Networks', and 'ICN'. The 'Symptoms' tab is active, displaying a list of symptoms and their severity scores. Below this, there are three columns for 'Hypothesis', 'Match', and 'Mismatch', each containing a list of Brodmann areas and hemispheres. To the right of the application window, two brain maps are shown, illustrating the anatomical hypotheses with numbered Brodmann areas. The top map shows a lateral view of the brain with areas 1-11, 17-19, 20, 21, 22, 37, 38, 39, 40, 41, 42, 43, 44, 45, 46, 47, 48, 49, 50, 51, 52, 53, 54, 55, 56, 57, 58, 59, 60, 61, 62, 63, 64, 65, 66, 67, 68, 69, 70, 71, 72, 73, 74, 75, 76, 77, 78, 79, 80, 81, 82, 83, 84, 85, 86, 87, 88, 89, 90, 91, 92, 93, 94, 95, 96, 97, 98, 99, 100. The bottom map shows a medial view of the brain with areas 1-11, 17-19, 20, 21, 22, 37, 38, 39, 40, 41, 42, 43, 44, 45, 46, 47, 48, 49, 50, 51, 52, 53, 54, 55, 56, 57, 58, 59, 60, 61, 62, 63, 64, 65, 66, 67, 68, 69, 70, 71, 72, 73, 74, 75, 76, 77, 78, 79, 80, 81, 82, 83, 84, 85, 86, 87, 88, 89, 90, 91, 92, 93, 94, 95, 96, 97, 98, 99, 100.

Symptom / Complaint	Severity
Mood - Hyperarousal	0
Concussion - Difficulty Multi-Tasking	0
Concussion - Short-Term Memory Problems	0
Concussion - Difficulty Concentrating	10
Concussion - Sleep Problems	0
Concussion - Balance Problems	0
Concussion - Problems Controlling Anger	0
Concussion - Depressed Mood	0
PTSD - Hyperarousal	0
PTSD - Sudden Fear Reactions	0

Hypothesis		Match		Mismatch	
Brodmann	Hem	Brodmann	Hem	Brodmann	Hem
9	Left	9	Right	1	Right
9	Right	10	Left	2	Right
10	Left	10	Right	3	Right
10	Right	11	Left	4	Left
11	Left	11	Right	4	Right
11	Right	23	Left	5	Left
23	Left	23	Right	5	Right
23	Right	24	Left	6	Left
24	Left	24	Right	6	Right
24	Right	30	Left	7	Left

**Use the Progress Chart as a Feedback Display and Move the Display to the Client's Monitor**

### Neurofeedback Setup Panel

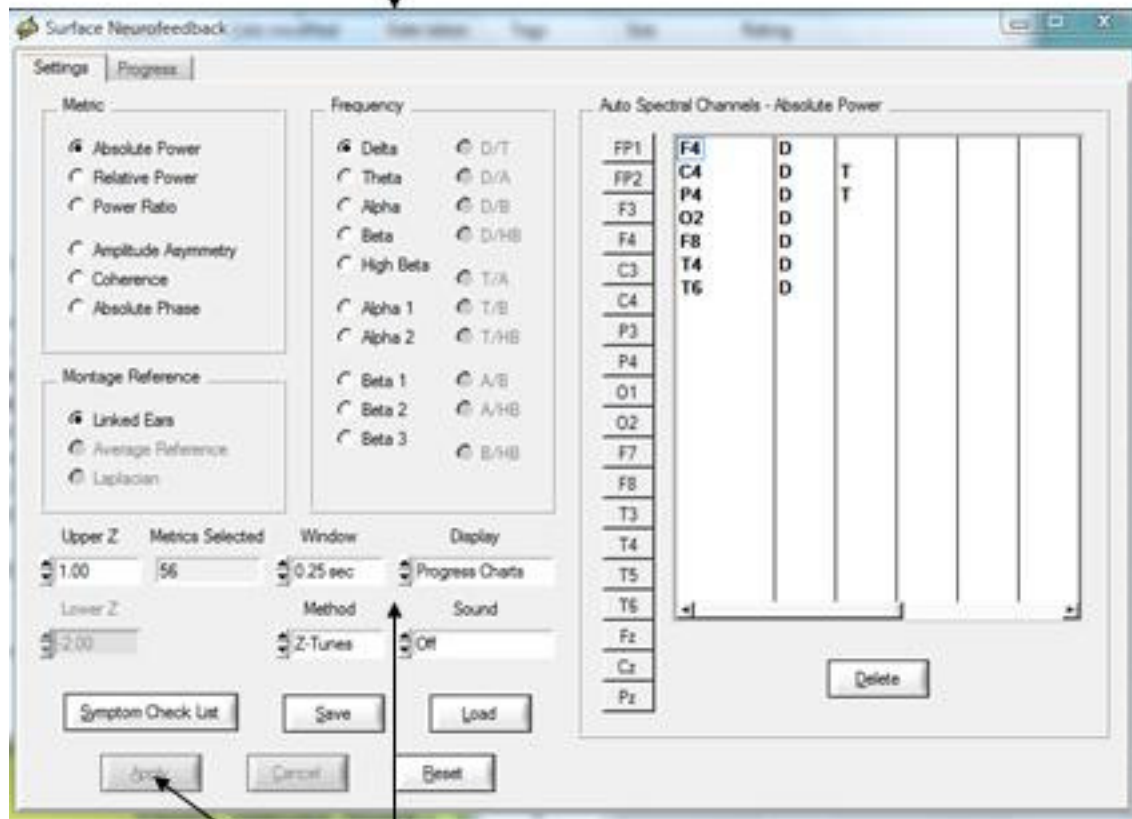

**Select Progress Charts as Feedback to A Client and then Click Apply**

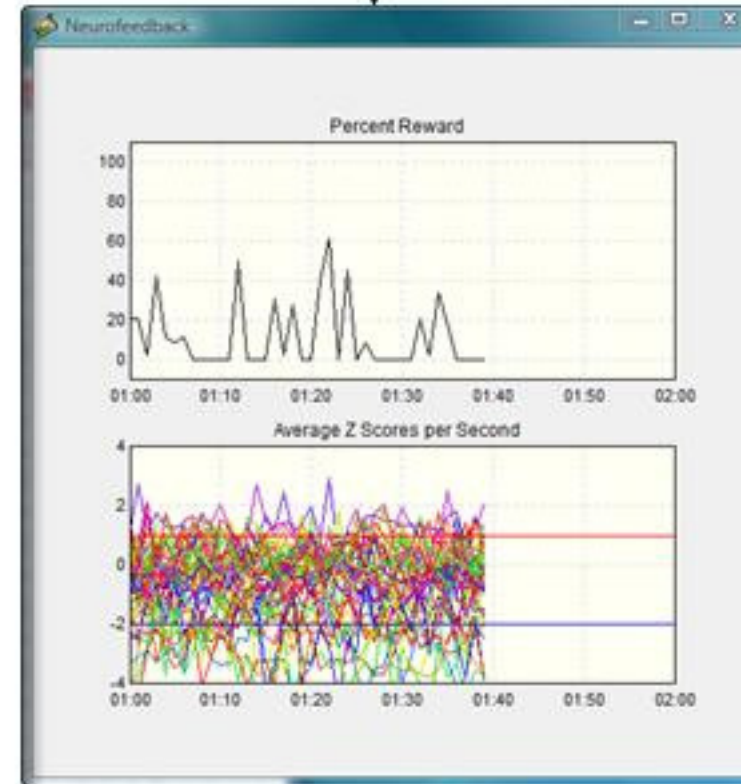

**Move to the Client's Monitor**



# Progress Charts to be Monitored by the Clinician During Neurofeedback

Toggle back & forth between to Settings Window & Progress Charts

Red Mark Designates Settings Change

View Instantaneous Z Scores

Percentage of Time that a Reward was Delivered (per sec)

Average Z Scores Updated Each Second

Z Score Range & Display Time Base  
1 min to 30 min

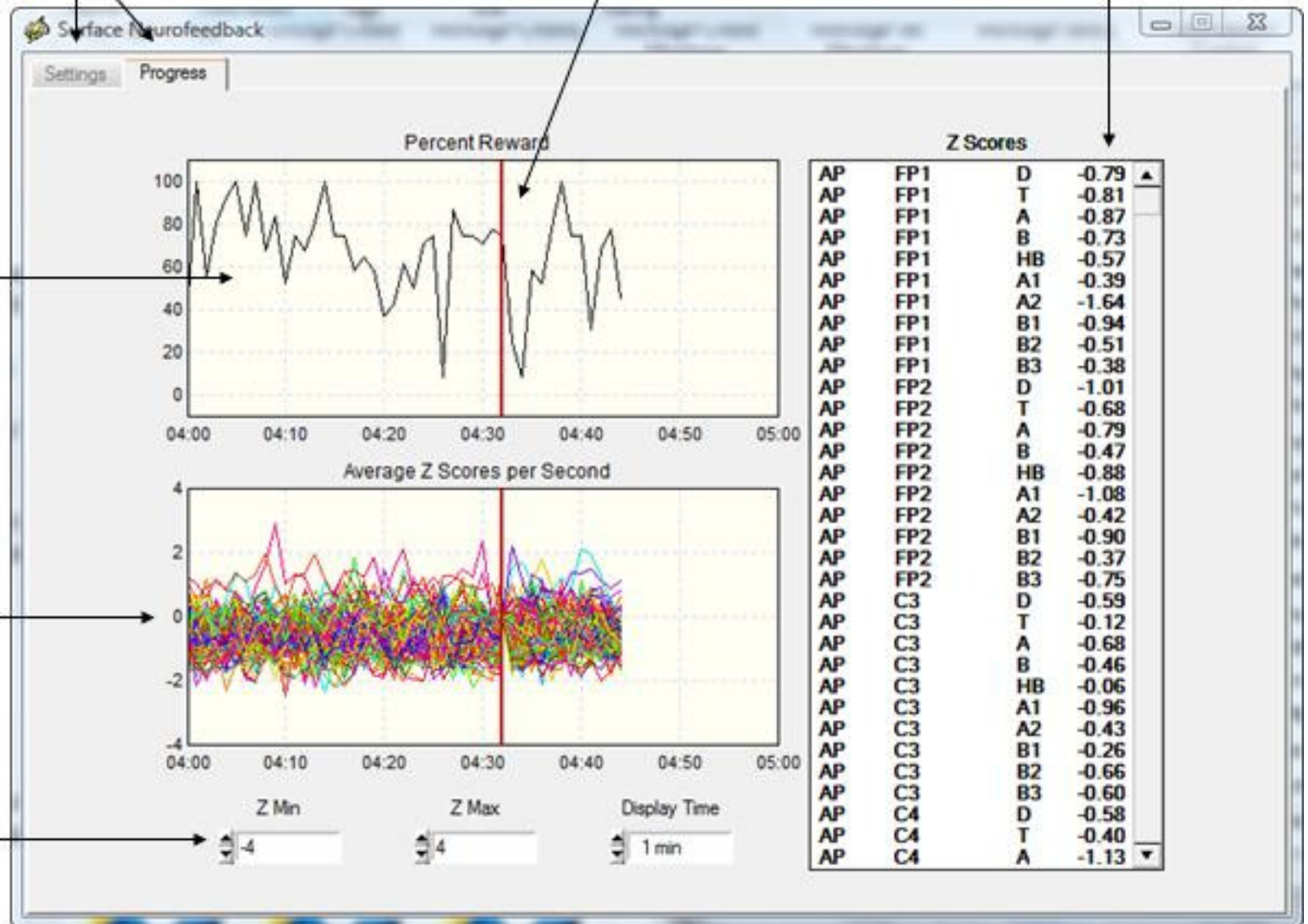

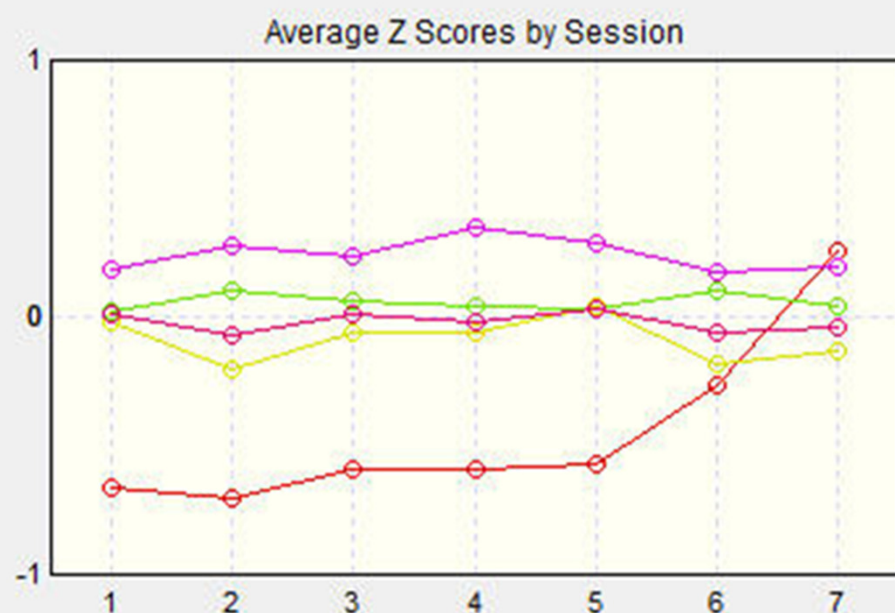
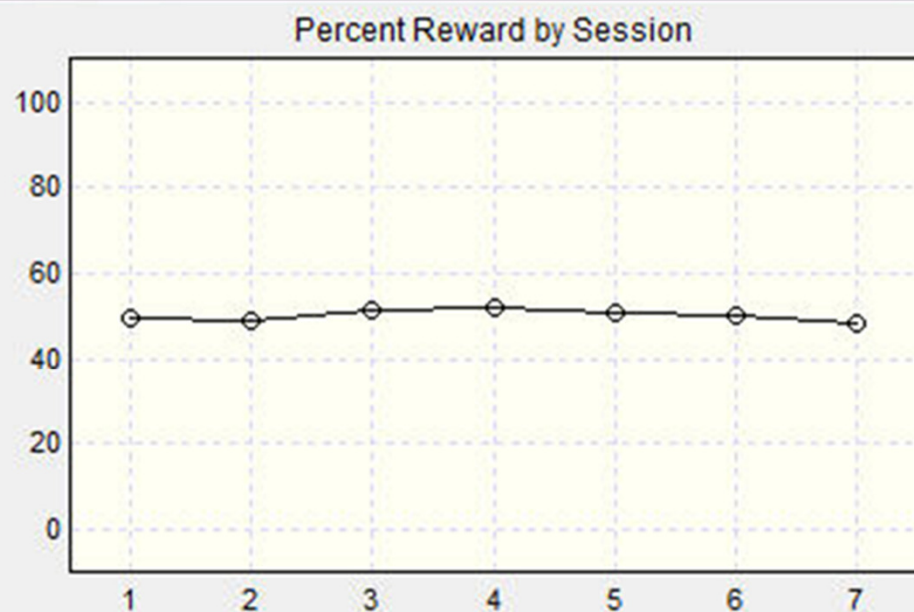

Z Max

1

Z Min

1

- Absolute Power
- Relative Power
- Power Ratio
- Amplitude Asymmetry
- Coherence
- Phase
- Phase Shift
- Phase Lock

Plot Selections

Plotted Data

Percent Reward by Session

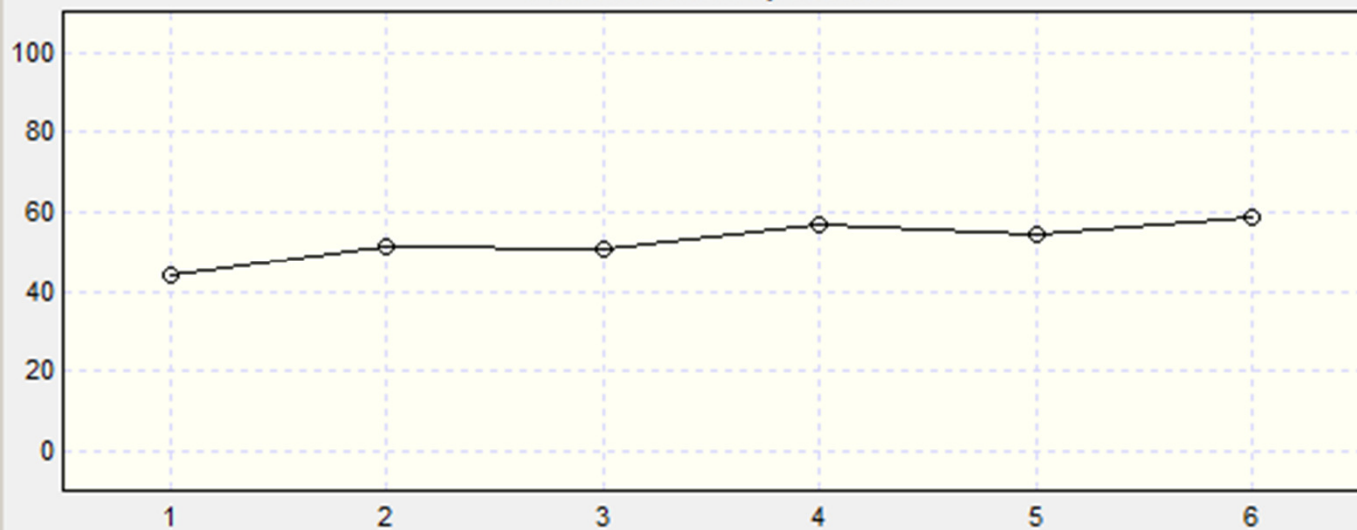

Average Z Scores by Session

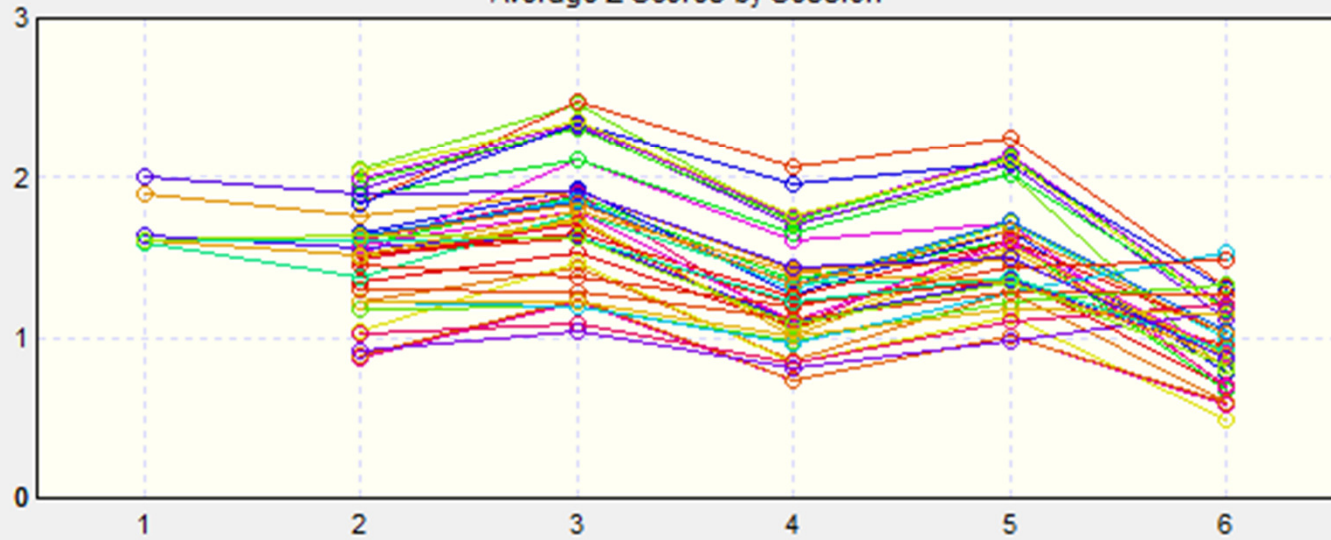

Plot Selections

Plotted Data

Percent Reward by Session

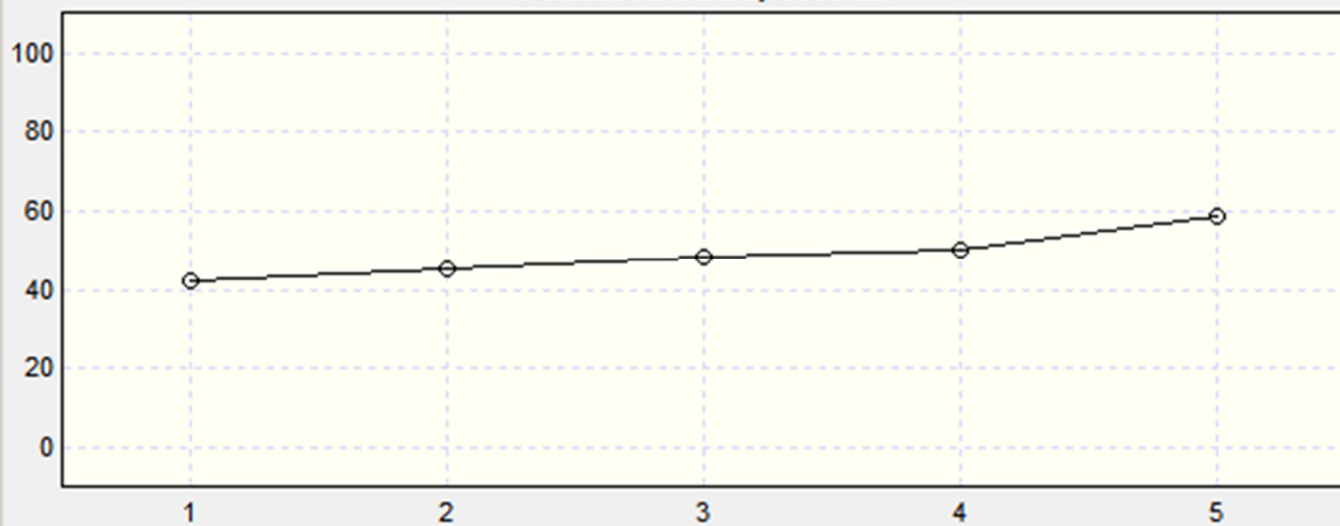

Average Z Scores by Session

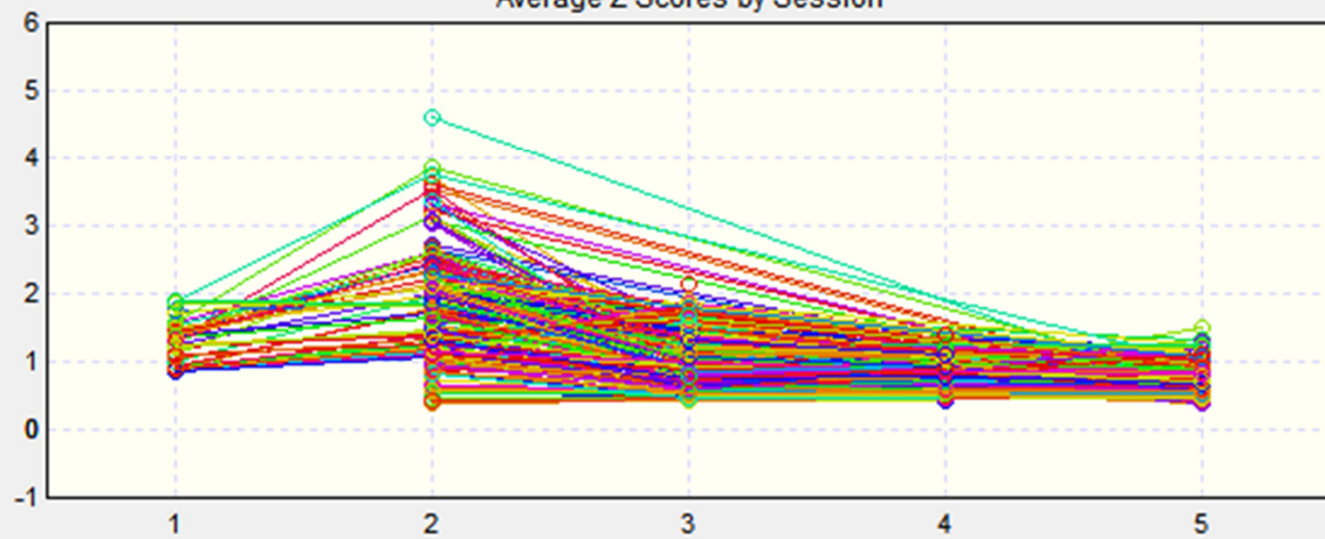

Average Z Scores by Session

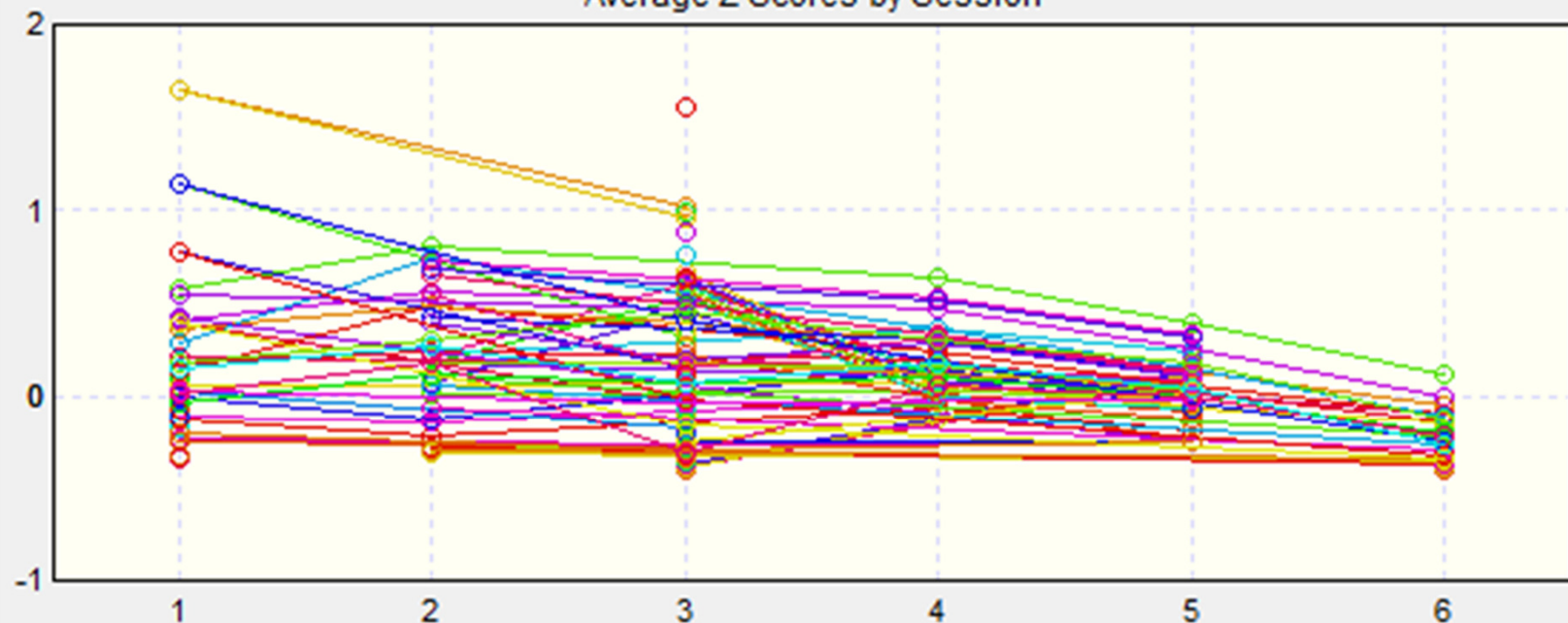

Average Z Scores by Session



# Examples of Surface EEG Changes After EEG Neurofeedback

## Pre-Treatment

## Post – 10 Treatments

TBI Subject #1

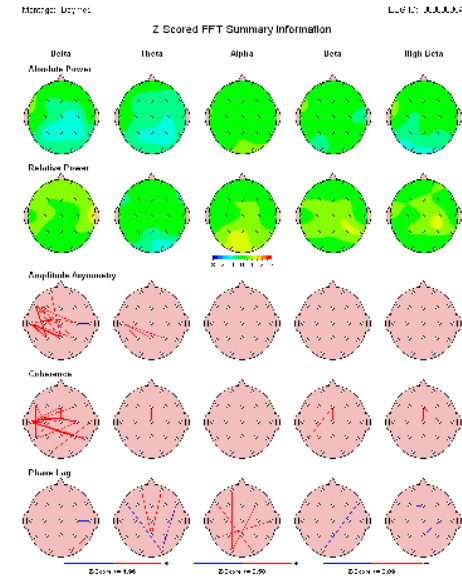
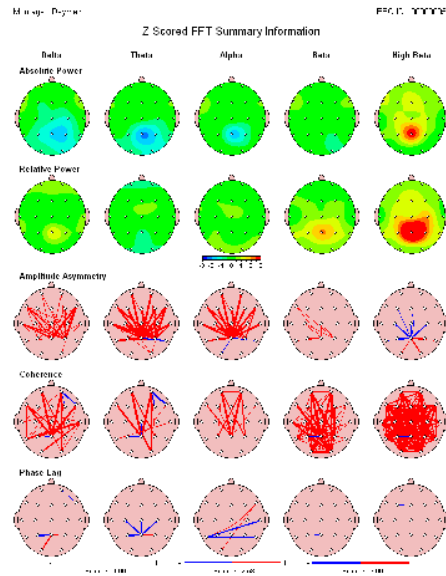

TBI Subject #2

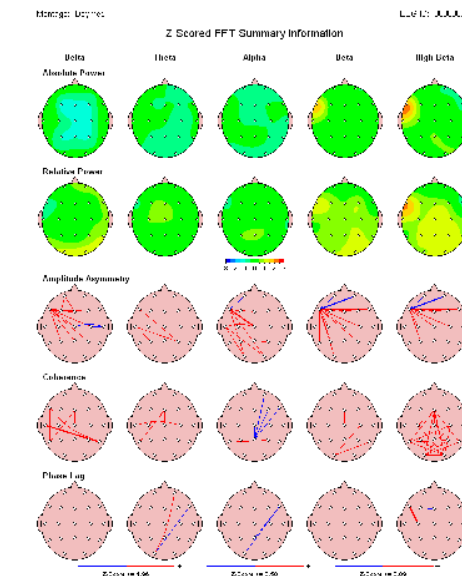
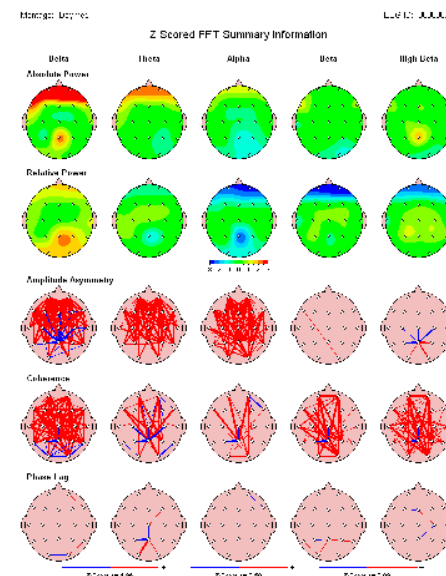

# Examples of Electrical Neuroimaging After Neurofeedback

Pre-Treatment

Post – 10 Treatments

S #1

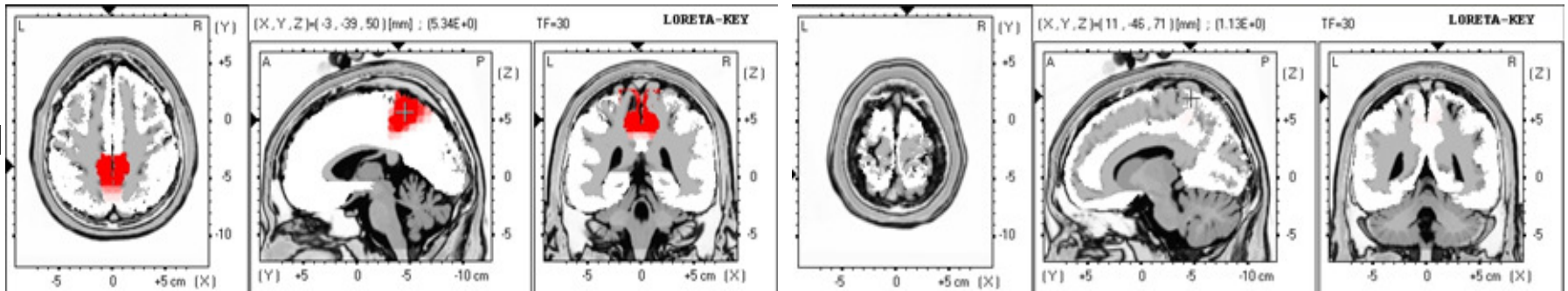

S #2

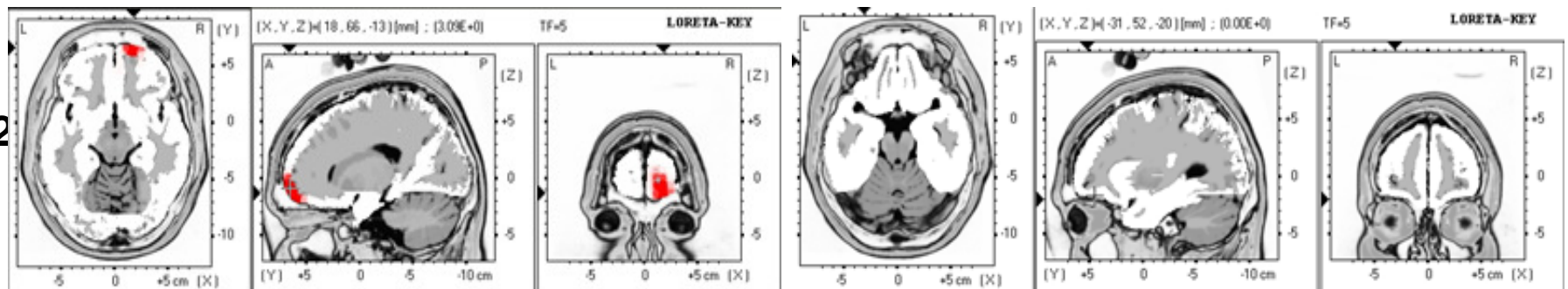

## Select a Network, Frequency and Metric

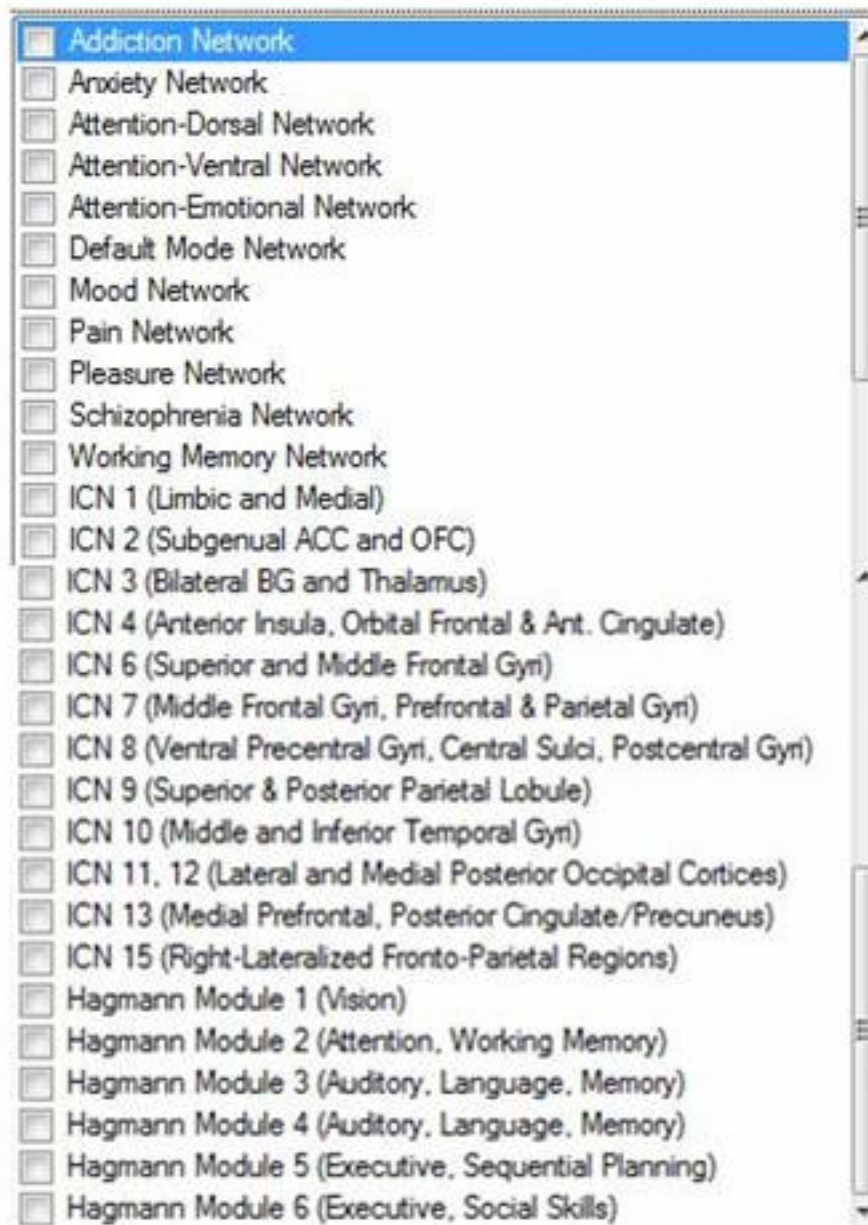

A list of brain networks with checkboxes. The 'Addiction Network' is selected, indicated by a blue highlight and a checked checkbox. The other networks have unchecked checkboxes.

- Addiction Network
- Anxiety Network
- Attention-Dorsal Network
- Attention-Ventral Network
- Attention-Emotional Network
- Default Mode Network
- Mood Network
- Pain Network
- Pleasure Network
- Schizophrenia Network
- Working Memory Network
- ICN 1 (Limbic and Medial)
- ICN 2 (Subgenual ACC and OFC)
- ICN 3 (Bilateral BG and Thalamus)
- ICN 4 (Anterior Insula, Orbital Frontal & Ant. Cingulate)
- ICN 6 (Superior and Middle Frontal Gyn)
- ICN 7 (Middle Frontal Gyn, Prefrontal & Parietal Gyn)
- ICN 8 (Ventral Precentral Gyn, Central Sulci, Postcentral Gyn)
- ICN 9 (Superior & Posterior Parietal Lobule)
- ICN 10 (Middle and Inferior Temporal Gyn)
- ICN 11, 12 (Lateral and Medial Posterior Occipital Cortices)
- ICN 13 (Medial Prefrontal, Posterior Cingulate/Precuneus)
- ICN 15 (Right-Lateralized Fronto-Parietal Regions)
- Hagmann Module 1 (Vision)
- Hagmann Module 2 (Attention, Working Memory)
- Hagmann Module 3 (Auditory, Language, Memory)
- Hagmann Module 4 (Auditory, Language, Memory)
- Hagmann Module 5 (Executive, Sequential Planning)
- Hagmann Module 6 (Executive, Social Skills)

